



Scan the code above to learn more about our Retractor portfolio.

# Retractor Portfolio



symmetry surgical™

# Retractors



Abdominal Self-Retaining	RET-2	General Purpose Lighted	RET-62	Orthopaedic Shoulder	RET-97	Spine Karlin™	RET-125
Abdominal Bookwalter® Bars	RET-8	General Purpose Self-Retaining	RET-62	Plastic Surgery Brow Lift	RET-97	Spine Micro Discectomy	RET-126
Abdominal Bookwalter® Blades	RET-10	Hysterectomy	RET-71	Plastic Surgery Hand	RET-97	Spine McCulloch	RET-127
Abdominal Bookwalter® Kits	RET-14	Laparoscopic	RET-72	Plastic Surgery Hand-Held	RET-98	Spine Nerve Root	RET-132
Abdominal Kits	RET-21	Laparoscopic Bookwalter®	RET-73	Prostatic	RET-98	Spine Self-Retaining	RET-135
Abdominal Bookwalter® Ratchets	RET-22	Lung	RET-74	Rectal Hand-Held	RET-99	Spine Bookwalter®	RET-136
Abdominal Bookwalter® Rings	RET-24	Mastectomy	RET-74	Rectal Self-Retaining	RET-99	Kits - Anterior Cervical Fusion	RET-138
Abdominal Bookwalter® Table Posts	RET-27	Mouth Gags	RET-75	Rectal Bookwalter®	RET-100	Kits - Cervical Retractor	RET-141
Abdominal Universal Blades	RET-28	Neuro Flap	RET-75	Rectal	RET-100	Splanchnic	RET-143
Abdominal Vision	RET-31	Neuro Hand-Held	RET-76	Redundant Wall	RET-101	Sternal	RET-144
Appendectomy	RET-32	Neuro Lachrymal Sac	RET-76	Renal Sinus	RET-102	Thoracotomy	RET-146
Cardiac Aorta	RET-32	Neuro Posterior Fossa	RET-77	Renal Vein	RET-102	Thymus	RET-147
Cardiac Aorta Valves	RET-33	Neuro Self-Retaining	RET-78	Renal	RET-102	Thymus Hand-Held	RET-147
Cardiac Atrial	RET-33	Neuro Greenberg®	RET-79	Rib Self-Retaining	RET-103	Thyroid	RET-147
Cardiac Atrial Valves	RET-33	Neuro	RET-84	Rib	RET-103	Tonsil	RET-148
Cardiac Epicardial	RET-34	Ophthalmology Hand-Held	RET-85	Scalp	RET-105	Tracheal	RET-149
Cardiac Bookwalter®	RET-34	Ophthalmology Lens Capsule	RET-86	Scapula	RET-107	Uvula	RET-150
Carotid Self-Retaining	RET-36	Ophthalmology Lid	RET-86	Septum	RET-108	Vaginal Bookwalter®	RET-151
Cerebellar	RET-37	Ophthalmology Orbital	RET-87	Spine Crockard™	RET-108	Vaginal	RET-154
Cheek	RET-37	Ophthalmology Self-Retaining	RET-88	Spine Cervical	RET-111	Vascular	RET-157
Deltoid	RET-38	Orthopaedic Bones	RET-89	Spine Decompression	RET-117	Vascular Vision	RET-158
Endaural	RET-38	Ophthalmology Hand	RET-91	Spine Dural	RET-117	Vein	RET-159
ENT (Mastoid)	RET-39	Orthopaedic Hand-Held	RET-91	Spine Hand-Held	RET-119	Vessel	RET-159
ENT (Nasal)	RET-39	Orthopaedic Hip	RET-92	Spine Hand-Held Retractor Set	RET-120		
Fiber Optic	RET-40	Orthopaedic Hip and Shoulder	RET-92	Spine Hemilaminectomy	RET-121		
Gall Bladders	RET-41	Orthopaedic Humeral	RET-94	Spine Lamina	RET-122		
General Purpose Finger Retractors	RET-42	Orthopaedic Humeral Head	RET-95	Spine Laminectomy	RET-122		
General Purpose Hand-Held	RET-43	Orthopaedic Knee	RET-95	Spine Lumbar	RET-124		

Questions? Contact us at [customerservice@symmetrysurgical.com](mailto:customerservice@symmetrysurgical.com) or learn more at [symmetrysurgical.com](http://symmetrysurgical.com)

# The Surgical Instrument Desk Reference

---

## How to Use Our Catalog

---

The Symmetry Surgical catalog is designed with you in mind, to be your trusted resource for surgical instrumentation. We took great care in creating an easy-to-use, robust catalog and we think you'll be pleased with the design as you become more familiar with our broad portfolio.

## Layout

---

The catalog is organized by surgical specialty *and* product function.

And we know that it is difficult to pick up an instrument and know what specialty it's listed in. To make your job easier, we've sorted the instruments in our portfolio by surgical function, too, including Energy, Laparoscopic, Retractors and Sterilization Solutions.

## U.S. Customer Service

---

Your Symmetry Surgical Customer Service team wants to make ordering surgical instruments the easiest part of your day. We accept orders via phone, fax, email, our website, Global Healthcare Exchange (GHX) and through the mail.

### PHONE

1.800.251.3000

(Available Monday through Friday, 8:30 AM–6:30 PM EST)

### FAX

1.800.342.3272

### EMAIL

[customerservice@symmetrysurgical.com](mailto:customerservice@symmetrysurgical.com)

### ONLINE

[symmetrysurgical.com](http://symmetrysurgical.com)

### MAILING ADDRESS

Symmetry Surgical  
Attn: Customer Service  
3034 Owen Drive  
Antioch, TN 37013

# The Surgical Instrument Desk Reference

## International Customer Service

### PHONE

Symmetry Surgical Switzerland GmbH  
+41 (0) 52 557 59 00  
(Available Monday through Friday, 7:00-16:00 GMT)

Symmetry Surgical, Inc., USA  
1.615.964.5672  
(Available Monday through Friday, 8:30 AM-6:30 PM EST)

### FAX

Symmetry Surgical Switzerland GmbH  
+41 (0) 52 557 59 99

### EMAIL

customerservice@symmetrysurgical.com  
internationalorders@symmetrysurgical.com

### ONLINE

symmetrysurgical.com

### MAILING ADDRESS

Symmetry Surgical Switzerland GmbH  
Bühlstrasse 27  
CH-8200 Schaffhausen  
Switzerland

Symmetry Surgical, Inc.  
3034 Owen Drive  
Antioch, TN 37013

### INTERNATIONAL PAYMENT TERMS/RETURN GOODS POLICY/INSTRUMENT REPAIR & RESTORE PROGRAM/LITERATURE REQUESTS

Please contact your local distributor. Locate a local distributor contact, International Customer Service at +41 (0) 52 557 59 00 or 1.615.964.5672 (US).

Cardiovascular/Thoracic

Energy

Ear, Nose & Throat

General

Laparoscopic

Neurology

Obesity

OB/GYN

Ophthalmology

Orthopedics & Arthroscopy

Pediatrics

Rectal

Retractors

Spine

Urology

Sterilization Solutions

Alphabetical & Numeric Indexes

## Abdominal (Self-Retaining)

### Balfour Abdominal Retractor

CODE	DIMENSIONS
24-5200AAA	16 x 2½ x 3½ in 406 x 63 x 89 mm



### Balfour Abdominal Retractor

CODE	DESCRIPTION	DIMENSIONS
24-5200A	Includes: Two Pairs Lateral Snap-On Wire Blades, Left Hand Assembly Provided Unless Specified Otherwise.	16 x 2½ x 3½ in 406 x 63 x 89 mm

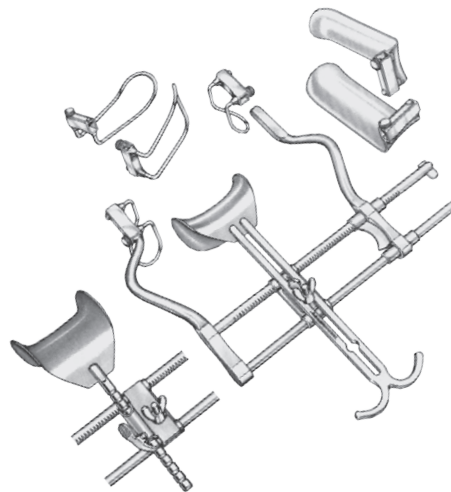

### Balfour Abdominal Retractor

CODE	DESCRIPTION	DIMENSIONS
24-5200AA	Includes: Two Pairs Lateral Snap-On Wire Blades, One Center Blade (Chosen From: 24-5012, 24-5014, 24-5022, 24-5024, 24-5026, 50-2428, 24-5030, 24-5032, 24-5034 or 24-5036). Left Hand Assembly Provided Unless Specified Otherwise.	16 x 2½ x 3½ in 406 x 63 x 89 mm

## Abdominal (Self-Retaining)



24-5200-1

### Balfour Abdominal Retractor

CODE	DESCRIPTION	DIMENSIONS	WIDTH	LENGTH
24-5200-1	Includes: Two Pairs Lateral Snap-On Wire Blades, One Center Blade (Left Hand Assembly Provided Unless Specified Otherwise)	8 1/2 x 2 1/2 x 3 1/2 in	216 x 63 x 89 mm	
24-5012			2 1/2 in 63 mm	1 3/4 in 44 mm
24-5014			3 5/8 in 92 mm	1 3/4 in 44 mm
24-5022			2 3/4 in 69 mm	2 5/8 in 66 mm
24-5024			3 3/8 in 85 mm	2 3/4 in 69 mm
24-5026			1 5/8 in 41 mm	2 5/8 in 66 mm
50-2428			1 5/8 in 41 mm	3 1/2 in 88 mm
24-5030			2 1/2 in 63 mm	2 5/8 in 66 mm
24-5032			2 1/2 in 63 mm	3 1/2 in 88 mm
24-5034			2 in 50 mm	6 1/2 in 165 mm
24-5036			2 1/2 in 63 mm	6 1/2 in 165 mm

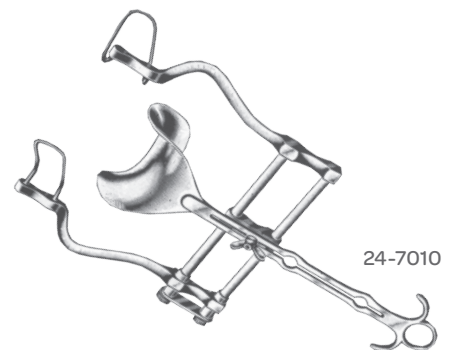

24-7010

### Balfour Abdominal Retractor

Standard Model with Fenestrated Blades 2 1/2 in (64 mm) Deep with Center Blade 24-7072 3 x 2 in (76 x 51 mm)

CODE	MAX SPREAD	DIMENSIONS
24-7010	7 1/8 in 181 mm	2 1/2 x 3 1/2 in 63 x 89 mm
24-7020	10 in 254 mm	

## Abdominal (Self-Retaining)

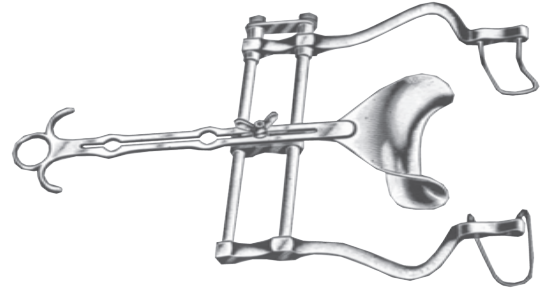

24-7020

### Balfour Abdominal Retractor

Standard Model: Fenestrated Blades 4 in (102 mm) Deep, with Center Blade 24-7073

CODE	MAX SPREAD
24-7073	3 <sup>3</sup> / <sub>8</sub> x 2 <sup>1</sup> / <sub>2</sub> in 86 x 64 mm
24-7015	7 <sup>1</sup> / <sub>8</sub> in 181 mm
24-7017	10 in 254 mm



### Balfour Abdominal Retractor

CODE	DESCRIPTION	DIMENSIONS (WxD)	LENGTH
50-4516	Center Blade, Standard	3 <sup>1</sup> / <sub>2</sub> x 1 <sup>3</sup> / <sub>4</sub> in 89 x 45 mm	9 <sup>3</sup> / <sub>4</sub> in 248 mm

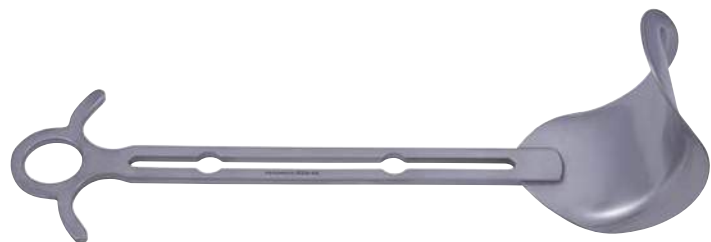

50-4521

### Balfour Abdominal Retractor

CODE	DESCRIPTION	DIMENSIONS (WxD)	DIMENSIONS
50-4521	Center Blade, Supra-Pubic	2 <sup>3</sup> / <sub>4</sub> x 2 <sup>3</sup> / <sub>4</sub> in 70 x 70 mm	9 <sup>1</sup> / <sub>2</sub> in 241 mm
50-4522	Center Blade, Supra-Pubic	3 <sup>1</sup> / <sub>4</sub> x 2 <sup>3</sup> / <sub>4</sub> in 83 x 70 mm	9 <sup>3</sup> / <sub>4</sub> in 248 mm

## Abdominal (Self-Retaining)



### Balfour Abdominal Retractor

Fenestrated Lateral Blade, One Pair

50-4504

CODE	DESCRIPTION	BLADE DEPTH
50-4504	Use with 50-4503 and 50-4509	2½ in 64 mm
50-4505	Use with 50-4503 and 50-4509	3½ in 89 mm
50-4506	Use with 50-4503 and 50-4509	4 in 102 mm
24-5201	Wire Lateral Blades for Use with 24-5200 Series	2½ in 64 mm
24-5203	Wire Blades for Use with 24-5200 Series	4 in 101 mm
24-5202	Solid Lateral Blades for Use with 24-5200 Series	2½ in 64 mm
24-5204	Solid Lateral Blades for Use with 24-5200 Series	4 in 101 mm



### Balfour Abdominal Retractor

Fourth Arm Attachment

50-4527

CODE	DESCRIPTION	DIMENSIONS
50-4527	Without Blade, Right	12 in 305 mm
50-4526	Without Blade, Left	12 in 305 mm



### Balfour Abdominal Retractor

CODE	DESCRIPTION	DIMENSIONS
50-5651	Miniature Model, Self-Retaining with Fixed Lateral Fenestrated Blades 1 x 1 in (25 x 25 mm) and One Center Blade 1 x 1 in (25 x 25 mm), Maximum Spread 3¾ in (95 mm).	3½ x 3¾ in 89 x 95 mm



## Abdominal (Self-Retaining)



### Balfour Fenestrated Retractor

With Two Lateral Blades and One Center Blade

CODE	TOTAL OPENING		LATERAL BLADE (W X D)		CENTER BLADE (W X D)	
50-4500	7 in	178 mm	1½ x 2 in	32 x 51 mm	3 x 2 in	76 x 51 mm



### Balfour Retractor Complete

Self-Retaining with Ratchet Crossbar

CODE	COMPLETE TOTAL OPENING		LATERAL BLADES (W X D)		CENTER BLADE (W X D)	
50-4514	7 in	178 mm	1½ x 2¼ in	38 x 57 mm	3¼ x 2¼ in	83 x 57 mm
			1½ x 3¼ in	38 x 83 mm	2½ x 2½ in	64 x 64 mm



### Horgan Abdominal Retractor

CODE	DESCRIPTION	DIMENSIONS	
50-4524	Malleable Center Blade	14 ¾ in	375 mm



### Wing Nut

CODE	DESCRIPTION
24-7002	Wing Nut

## Abdominal (Self-Retaining)



### Balfour Retractor with Fenestrated Blades

Abdominal Retractor, Self-Retaining with Trigger Ratchet. Includes Two Pair of Detachable Lateral Fenestrated Blades and One Center Blade

CODE	TOTAL OPENING	LATERAL BLADES (W X D)	CENTER BLADE (W X D)	TOTAL WIDTH
50-4503	7 <sup>5</sup> / <sub>8</sub> in 194 mm	1 <sup>3</sup> / <sub>4</sub> x 2 <sup>1</sup> / <sub>2</sub> in 44 x 64 mm	2 <sup>1</sup> / <sub>2</sub> x 2 <sup>1</sup> / <sub>2</sub> in 64 x 64 mm	7 <sup>5</sup> / <sub>8</sub> 194 mm
		1 <sup>3</sup> / <sub>4</sub> x 3 <sup>3</sup> / <sub>8</sub> in 44 x 86 mm		

Also Available in a 10<sup>1</sup>/<sub>2</sub> in Diameter. Part number: 50-4509.



### Balfour Retractor with Fenestrated Blades

Abdominal Retractor, Self-Retaining. With Two Fixed Blades, Two Removable Small Blades and One Large Removable Blade

CODE	TOTAL OPENING	LATERAL BLADE (W X D)	CENTER BLADE (W X D)
50-4510	8 <sup>1</sup> / <sub>2</sub> in 216 mm	1 <sup>1</sup> / <sub>2</sub> x 2 <sup>1</sup> / <sub>2</sub> in 38 x 64 mm	2 <sup>1</sup> / <sub>2</sub> x 2 <sup>1</sup> / <sub>2</sub> in 64 x 64 mm



### O'Connor-O'Sullivan Abdominal Retractor

CODE	DESCRIPTION	LENGTH
24-8500	Complete Set (24-8509, 24-8511, 24-8512)	
24-8509	Frame Only, with 2 Rotatable Lateral Blades Attached	1 x 2 <sup>1</sup> / <sub>3</sub> in 25 x 60 mm
24-8511	Center Blade, 2/Each Included in 24-8500	1 <sup>3</sup> / <sub>4</sub> x 3 <sup>1</sup> / <sub>4</sub> in 44 x 83 mm
24-8512	Center Blade, 1/Each Included in 24-8500	2 <sup>3</sup> / <sub>4</sub> x 4 <sup>1</sup> / <sub>8</sub> in 70 x 105 mm
24-8599	Wing Nuts (Pair)	

## Abdominal (Bookwalter® Bars)

### Bookwalter® Violi Gooseneck Table Post

CODE	DESCRIPTION
50-4681	Table Post for 1 in (25 mm) System



### Bookwalter® Lightweight Horizontal Bar

CODE	DESCRIPTION	LENGTH
50-4552	Horizontal Bar	14¼ in 362 mm



### Bookwalter® Lightweight Horizontal Flex Bar

CODE	DESCRIPTION
50-4582	Lightweight Horizontal Flex Bar



### Bookwalter® Ironman Horizontal

CODE	DESCRIPTION
50-4678	Violi Ironman Horizontal Ring Holder



## Abdominal (Bookwalter® Bars)

### Bookwalter® Lightweight Horizontal Bar

CODE	DESCRIPTION	LENGTH
50-4618	Horizontal Bar	15¼in 387 mm

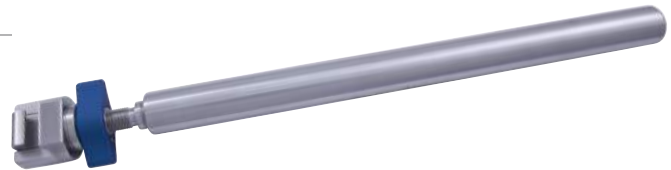

### Bookwalter® Lightweight Extension Bar

Requires the Use of a Second Bookwalter® Post Coupler 50-4554

CODE	DIMENSIONS
50-4553	12 in 305 mm
50-4797	18 in 458 mm



50-4553

### Bookwalter® Balfour Blade

CODE	DIMENSIONS
50-4576	2¾ x 3in 70 x 76 mm
BW1271017	3½ x 2¾ in 89 x 70 mm



50-4576

### Bookwalter® Gelpi Blade

CODE	DIMENSIONS
50-4577	1 x 5 in 25 x 127 mm

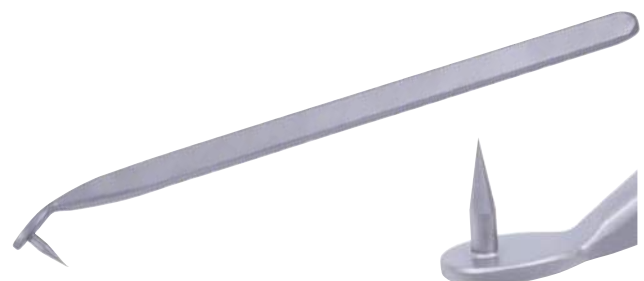

## Abdominal (Bookwalter® Blades)



50-4566

### Bookwalter® Harrington Blade

CODE	DIMENSIONS
50-4566	2½ x 5⅝ in 63 x 143 mm
BW1045176	3½ x 10 in 89 x 254 mm



50-4568

### Bookwalter® Kelly Blade

CODE	DESCRIPTION	WIDTH	DEPTH
50-4574	Kelly Blade	1 in 25 mm	1 in 25 mm
50-4575	Kelly Blade	1 in 25 mm	2½ in 64 mm
50-4565	Kelly Blade	2 in 51 mm	1½ in 38 mm
50-4563	Kelly Blade	2 in 51 mm	2 in 51 mm
50-4572	Kelly Blade	2 in 51 mm	2½ in 64 mm
50-4568	Kelly Blade	2 in 51 mm	3 in 76 mm
50-4569	Kelly Blade	2 in 51 mm	4 in 102 mm
50-4570	Kelly Blade	2 in 51 mm	5 in 127 mm
50-4571	Kelly Blade	2 in 51 mm	6 in 152 mm
BW1045000	Kelly Blade	2 in 51 mm	8 in 203 mm

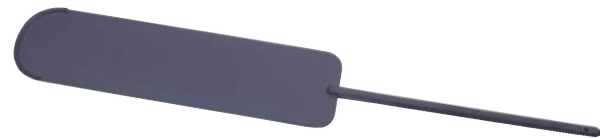

67-7499

### Bookwalter® Opti-Length® Retractor Blade

Malleable with Lip

CODE	DIMENSIONS
67-7502	1½ x 11 in 38 x 279 mm
67-7504	2 x 11 in 51 x 279 mm
67-7499	3 x 11 in 76 x 279 mm
67-7500	4 x 11 in 102 x 279 mm

## Abdominal (Bookwalter® Blades)



50-4644

### Bookwalter® Rake Retractor

CODE	DESCRIPTION	WIDTH	DEPTH
50-4644	3 Prong	$\frac{2}{3}$ in 17 mm	$\frac{3}{4}$ in 19 mm
50-4645	4 Prong	$\frac{3}{4}$ in 19 mm	$\frac{1}{3}$ in 8.4 mm
50-4646	6 Prong	1 in 25 mm	$\frac{1}{3}$ in 8.4 mm



50-4598

### Bookwalter® Richardson Blade

CODE	DIMENSIONS
50-4597	$\frac{3}{4}$ x 1 in 19 x 25 mm
50-4598	$\frac{3}{4}$ x 2 in 19 x 51 mm
50-4599	1 x $1\frac{1}{4}$ in 25 x 32 mm

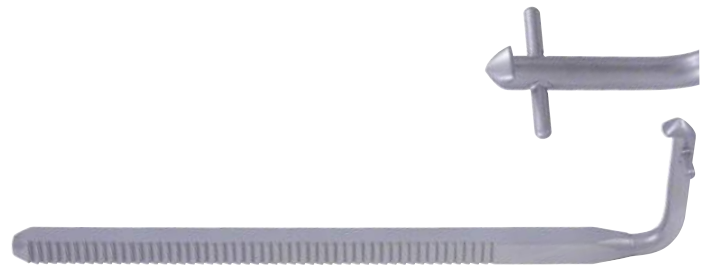

50-4639

### Bookwalter® Scoville Hook

CODE	DESCRIPTION	DIMENSIONS
50-4639	Small	2 in 51 mm
50-4640	Large	$3\frac{1}{4}$ in 83 mm



50-4641

### Bookwalter®-Meyerding Retractor Blade

CODE	DESCRIPTION	DIMENSIONS
50-4641	Small	$\frac{2}{3}$ x $2\frac{1}{3}$ in 17 x 60 mm
50-4642	Medium	1 x $3\frac{1}{3}$ in 25 x 85 mm
50-4643	Large	2 x $3\frac{3}{4}$ in 51 x 95 mm

## Abdominal (Bookwalter® Blades)



50-4561

### Bookwalter® Malleable Retractor Blade

Stainless Steel Matte Finish

CODE	WIDTH X LENGTH
50-4561	2 x 6 in 51 x 152 mm
50-4562	1½ x 6 in 38 x 152 mm
50-4567	3 x 6 in 76 x 152 mm
BW1043016	2 x 10 in 51 x 254 mm
BW1043029	3 x 10 in 76 x 254 mm
BW1045069	4 x 8 in 101 x 203 mm



50-4673

### Bookwalter® Retractor Blade

Malleable with Lip

CODE	DESCRIPTION	DIMENSIONS
50-4673	Small	2 x 6 in 51 x 152 mm
50-4672	Medium	1½ x 6 in 38 x 152 mm



50-4694

### Bookwalter® Retractor Blade

Malleable with Lip

CODE	DESCRIPTION	DIMENSIONS
50-4694	Short	1 x 4 in 25 x 102 mm
50-4674	Large	3 x 6 in 76 x 152 mm



50-4669

### Bookwalter® Retractor Blade

Super Malleable with Lip

CODE	DESCRIPTION	DIMENSIONS
50-4669	Small	1½ x 6 in 38 x 152 mm
50-4670	Medium	2 x 6 in 51 x 152 mm
50-4671	Large	3 x 6 in 76 x 152 mm

## Abdominal (Bookwalter® Blades )



### Bookwalter® -Magrina Retractor Blade

CODE	DESCRIPTION	DIMENSIONS	
50-4691	Super Malleable with Lip	1 x 4 in	25 x 102 mm



### Bookwalter® Radiolucent Titanium Blade

Low Glare Gold Coating

CODE	DESCRIPTION	DIMENSIONS (W X L)		CODE	DESCRIPTION	DIMENSIONS (W X L)	
50-5580	Titanium Blade	1 x 4 in	25 x 102 mm	50-5585	Titanium Blade	2 x 4 in	51 x 102 mm
50-5581	Titanium Blade	1 x 5 in	25 x 127 mm	50-5586	Titanium Blade	2 x 5 in	51 x 127 mm
50-5582	Titanium Blade	1 x 6 in	25 x 152 mm	50-5587	Titanium Blade	2 x 6 in	51 x 152 mm
50-5583	Titanium Blade	1 x 7 in	25 x 178 mm	50-5588	Titanium Blade	2 x 7 in	51 x 178 mm
50-5584	Titanium Blade	1 x 8 in	25 x 203 mm	50-5589	Titanium Blade	2 x 8 in	51 x 203 mm

### Bookwalter® Lightweight Post Coupling

CODE	DESCRIPTION
50-4554	For a 1 in (25 mm) System





## Abdominal (Bookwalter® Kits)

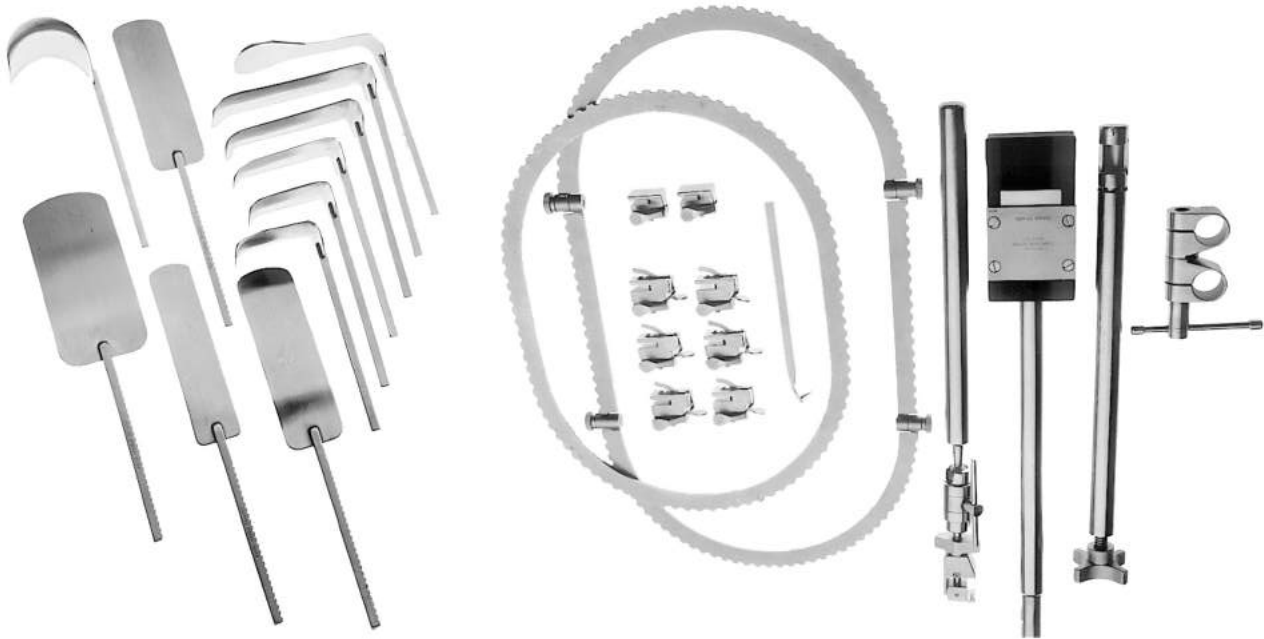

### Bookwalter® Retractor Kit II

CODE	DESCRIPTION	LENGTH		QTY
50-4542	Includes Part Numbers and Quantities Listed Below:			
50-4581	Table Post	12 in	304 mm	1
50-4554	Post Coupling			1
50-4552	Horizontal Bar	14 ¼ in	365 mm	1
50-4582	Horizontal Flex Bar			1
50-4557	Medium Oval Ring			1
50-4583	Segmented Ring			1
50-4579	Ratchet Mechanisms			2
50-4580	Tilt Ratchet Mechanisms			6
50-4566	Harrington Retractors			1
50-4576	Balfour Retractors			1
50-4568	Kelly Retractors	2 x 3 in	51 x 76 mm	2
50-4569	Kelly Retractors	2 x 4 in	51 x 102 mm	1
50-4570	Kelly Retractors	2 x 5 in	51 x 127 mm	1
50-4571	Kelly Retractors	2 x 6 in	51 x 152 mm	1
50-4562	Malleable Retractors	1 ½ x 6 in	38 x 152 mm	1
50-4561	Malleable Retractors	2 x 6 in	51 x 152 mm	2
50-4567	Malleable Retractors	3 x 6 in	76 x 152 mm	1
50-4577	Gelpi Retractor			1
<b>ACCESSORIES</b>				
50-4507	Table Fixation and Ring Case			1
50-4508	Blade and Accessories Case			1

## Abdominal (Bookwalter® Kits)

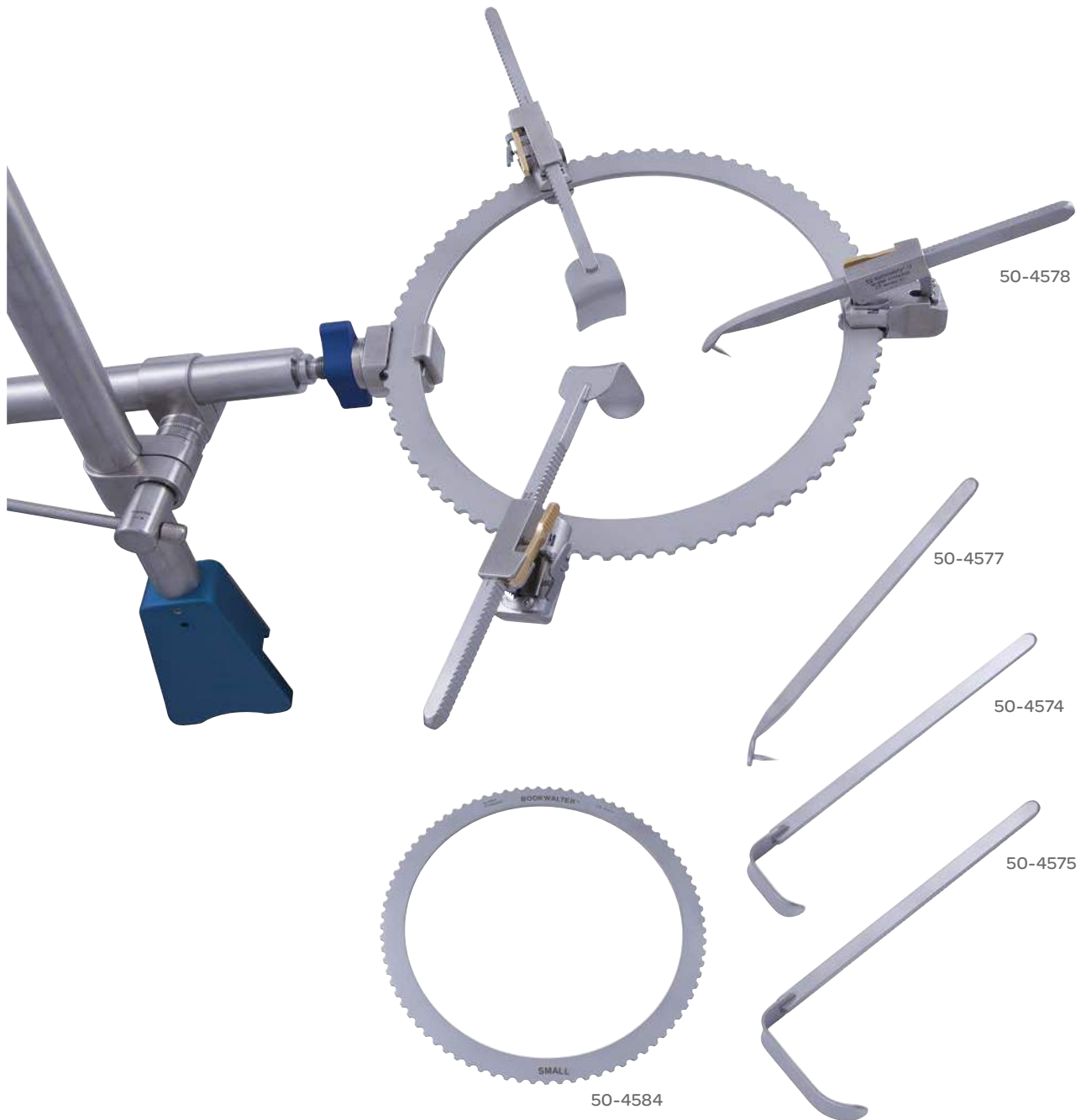

### Bookwalter® Small Incision Kit

CODE	DESCRIPTION	LENGTH
50-4578	Includes Part Numbers Listed Below:	
50-4584	Round Ring	8½ in 216 mm
50-4577	Retractor Gelpi Blade	
50-4574	Kelly Retractor Blades	1x1½ in 25x38 mm
50-4575	Kelly Blade	1x2½ in 25x64 mm

## Abdominal (Bookwalter® Kits)

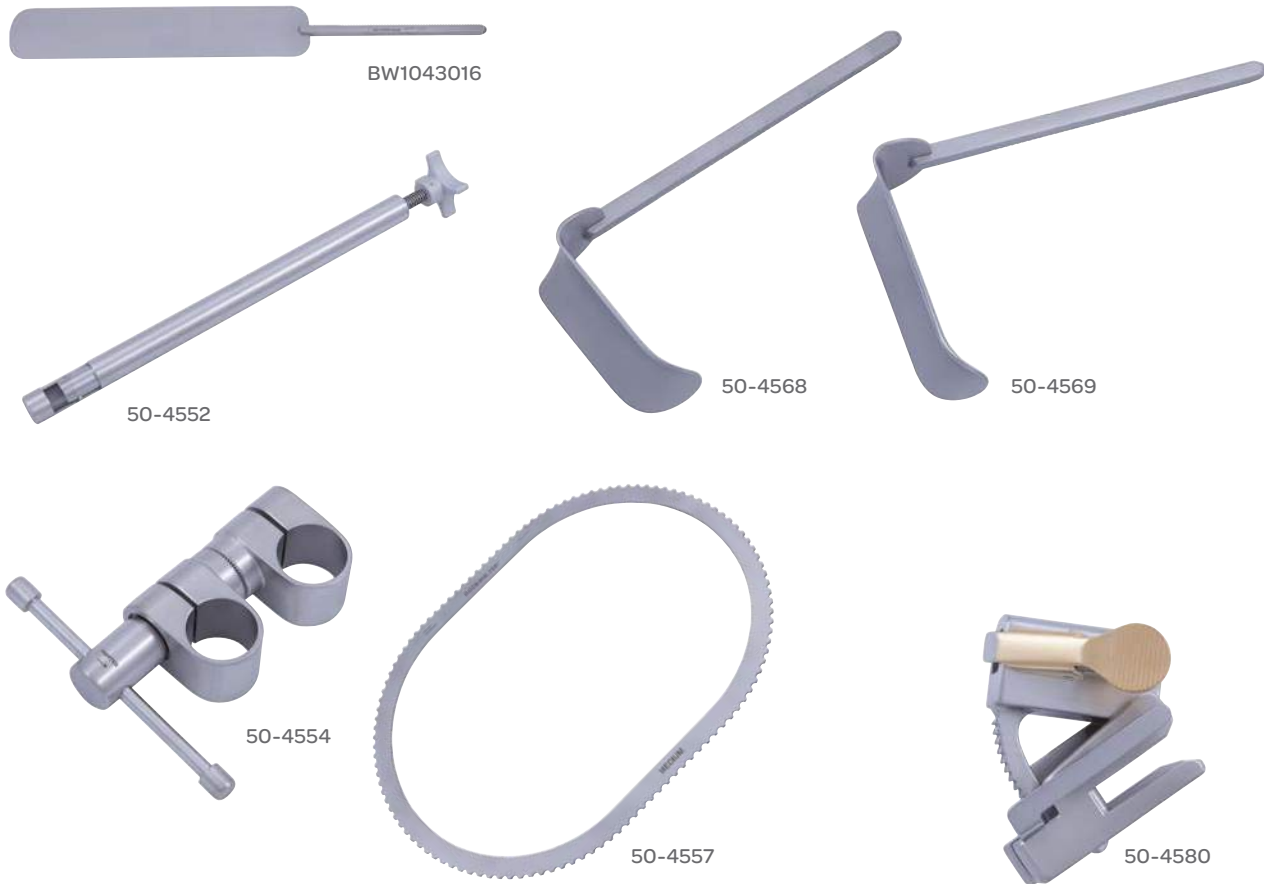

### Bookwalter® Obese Patient Retractor System, 18 Inch (458 mm) Table Post

CODE	DESCRIPTION	DIMENSIONS		QTY
BW1046BKIT	Includes Part Numbers Listed Below:			
BW0144005	Table Post Obese Patients	18 in	458 mm	1
BW1043016	Malleable Blade	2 x 10 in	51 x 254 mm	1
BW1043029	Malleable Blade	3 x 10 in	76 x 254 mm	1
BW1045069	Malleable Blade	4 x 8 in	102 x 203 mm	1
BW1045000	Kelly Blade	2 x 8 in	51 x 203 mm	1
BW1271017	Balfour Blade	3½ x 2¾ in	89 x 70 mm	1
BW1045176	Harrington Blade	3½ x 10 in	89 x 254 mm	1
BW0338014	Ratchet Extender			1
BW0338015	Twister Ratchet			1
50-4552	Horizontal Bar	14¼ in	365 mm	1
50-4554	Post Coupling	1 x 1 in	25 x 25 mm	1
50-4557	Retractor, Oval Ring Medium			1
50-4568	Kelly Retractor Blades	2 x 3 in	51 x 76 mm	1
50-4569	Kelly Retractor Blades	2 x 4 in	51 x 102 mm	1
50-4580	Tilting Ratchets			6

## Abdominal (Bookwalter® Kits)



### Bookwalter® Obese Patient Accessory Kit, 18 Inch (458 mm) Table Post

CODE	DESCRIPTION	DIMENSIONS		QTY
BW1046BRT	Includes Part Numbers Listed Below:			
BW0144005	Table Post			1
BW1043016	Malleable Blade	2 x 10 in	51 x 254 mm	1
BW1043029	Malleable Blade	3 x 10 in	76 x 254 mm	1
BW1045069	Malleable Blade	4 x 8 in	102 x 203 mm	1
BW1045000	Kelly Blade	2 x 8 in	51 x 203 mm	1
BW1271017	Balfour Blade	3½ x 2¾ in	89 x 70 mm	1
BW1045176	Harrington Blade	3½ x 10 in	89 x 254 mm	1
BW0338014	Ratchet Extender			1
BW0338015	Twister Ratchet			1



### Bookwalter® Obese Patient Accessory Kit, 24 Inch (610 mm) Table Post

CODE	DESCRIPTION	DIMENSIONS		QTY
BW1045BRT	Includes Part Numbers Listed Below:			
BW0144003	Table Post	24 in	610 mm	1
BW1043016	Malleable Blade	2 x 10 in	51 x 254 mm	1
BW1043029	Malleable Blade	3 x 10 in	76 x 254 mm	1
BW1045069	Malleable Blade	4 x 8 in	102 x 203 mm	1
BW1045000	Kelly Blade	2 x 8 in	51 x 203 mm	1
BW1271017	Balfour Blade	3½ x 2¾ in	89 x 70 mm	1
BW1045176	Harrington Blade	3½ x 10 in	89 x 254 mm	1
BW0338014	Ratchet Extender			1
BW0338015	Twister Ratchet			1

## Abdominal (Bookwalter® Kits)



### Bookwalter® Obese Patient Retractor System, 24 Inch (610 mm) Table Post

CODE	DESCRIPTION	LENGTH		QTY
BW1045BKIT	Includes Part Numbers Listed Below:			
BW0144003	Table Post	24 in	610 mm	1
BW1043016	Malleable Blade	2 x 10 in	51 x 254 mm	1
BW1043029	Malleable Blade	3 x 10 in	76 x 254 mm	1
BW1045069	Malleable Blade	4 x 8 in	102 x 203 mm	1
BW1045000	Kelly Blade	2 x 8 in	51 x 203 mm	1
BW1271017	Balfour Blade	3½ x 2¾ in	89 x 70 mm	1
BW1045176	Harrington Blade	3½ x 10 in	89 x 254 mm	1
BW0338014	Ratchet Extender			1
BW0338015	Twister Ratchet			1
50-4552	Horizontal Bar	14¼ in	365 mm	1
50-4554	Post Coupling	1 x 1 in	25 x 25 mm	1
50-4557	Medium Oval Ring			1
50-4568	Kelly Blade	2 x 3 in	51 x 76 mm	1
50-4569	Kelly Blade	2 x 4 in	51 x 102 mm	1
50-4580	Tilt Ratchets			6



### Bookwalter® Richardson Blade Kit

CODE	DESCRIPTION	LENGTH	
50-4596	Includes One of the Following Three Blades:		
50-4597	Blade	¾ x 1 in	19 x 25 mm
50-4598	Blade	¾ x 2 in	19 x 51 mm
50-4599	Blade	1 x 1¼ in	25 x 32 mm

## Abdominal (Bookwalter® Ratchets)

### Bookwalter® Flat Ratchet

CODE	DESCRIPTION	QTY
50-4579	Basic Ratchet provides simple retraction at 0° angle to the surgical site.	1/ Each Sold Individually



### Bookwalter® Tilt Ratchet

CODE	DESCRIPTION	QTY
50-4580	Tilt ratchet articulates the blade into the surgical site.	1/ Each Sold Individually



### Bookwalter Rotilt® Ratchet

CODE	DESCRIPTION	QTY
50-4589	The Rotilt Ratchet twists the blade in 7 indexed positions along a 60° arch and has the ability to independently articulate the blade into the surgical site.	1/ Each Sold Individually



## Abdominal (Bookwalter® Ratchets)

### Bookwalter® Self-Retaining Low Profile Locking Rotilt Ratchet

CODE	DESCRIPTION	QTY
504695	Self-Retaining Low Profile Locking Rotilt	1/ Each Sold Individually



### Bookwalter® Self-Retaining Tilt Ratchet

CODE	DESCRIPTION	QTY
50-4686	Like the 50-4580 this ratchet articulates the blade into the surgical site, it also has an additional self-retention latch that holds the ratchet onto the Bookwalter® Retractor Ring.	1/ Each Sold Individually



### Bookwalter® Self-Retaining Low Profile Locking Rotilt Ratchet

CODE	DESCRIPTION	QTY
50-4696	The Bookwalter® Self-Retaining Low Profile Locking RoTilt Ratchet bring all of the best features of all other ratchets into one mechanism. The low profile design, inclusive of the capacity to tilt, rotate and self-retention it is the one ratchet to build your Bookwalter® Set.	1/ Each Sold Individually



### Bookwalter® Twister Ratchet

CODE	DESCRIPTION	QTY
BW0338015	Twister Ratchet	1/ Each Sold Individually

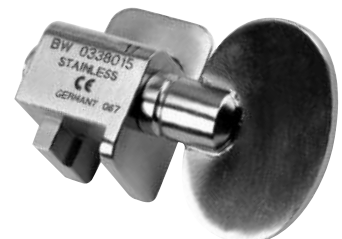

## Abdominal (Bookwalter® Ratchets)

### Bookwalter® Ratchet Extender



CODE	DESCRIPTION
BW0338014	Ratchet Extender

## Abdominal (Bookwalter® Rings)



504810

### Bookwalter® Adaptable Ring System

Table Mounted

CODE	DESCRIPTION
50-4810	System Includes the Horizontal Bar and Dual Ball Joint Hinge System as well as the Small Round, Medium Round and Medium Oval Ring Segments.
50-4811	Small Round Ring Sements
50-4812	Medium Round Ring Segments
50-4813	Medium Oval Ring Segments

### Bookwalter® Adaptable Ring System Bridge



CODE	DESCRIPTION
50-4687	For use with 50-4810

### Bookwalter® Segmented Elliptical Ring



CODE	DESCRIPTION	DIMENSIONS	
50-4595	Elliptical Ring	14 ½ x 15 in	368 x 380 mm



## Abdominal (Bookwalter® Rings)

### Bookwalter® Oval Ring

CODE	DESCRIPTION	DIMENSIONS	
50-4558	Small	8 x 12¼ in	203 x 311 mm
50-4557	Medium	10 ½ x 14 ½ in	267 x 368 mm
50-4556	Large	12 x 18 ½ in	305 x 470 mm

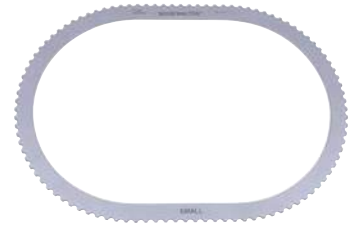

50-4558

### Bookwalter® Round Ring

Table Mounted

CODE	DESCRIPTION	DIAMETER	
50-4584	Small	8 ½ in	216 mm
50-4559	Medium	10 ½ in	267 mm
50-4560	Large	12 ½ in	318 mm

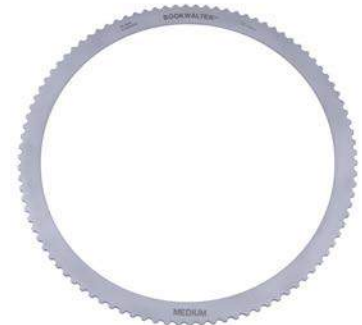

50-4559

### Bookwalter® Suture Ring

CODE	DESCRIPTION	DIAMETER	
50-4684	Small, Round	9 ½ in	241 mm



### Bookwalter® Round Ring Segmented

CODE	DESCRIPTION	DIAMETER	
50-4635	Small, 1 Pair	8 ½ in	216 mm
50-4634	Medium, 1 Pair	10 ½ in	267 mm
50-4633	Large, with Suture Slots	16 in	406 mm



50-4635

## Abdominal (Bookwalter® Rings)



50-4587

### Bookwalter® Segmented Retractor Ring

CODE	DESCRIPTION	DIMENSIONS
50-4587	Small, Consists of One 8 ½ in Round Ring and Two 4 in Straight Segments	8 ½ x 14 in 216 x 356 mm
50-4583	Medium, Consists of One 10 ½ in Round Ring and Two 8 in Straight Segments	10 ½ x 19 ½ in 267 x 495 mm
50-4588	Large, Consists of One 12 ½ in Round Ring and Two 6 in Straight Segments	12 ½ x 19 ½ in 318 x 495 mm

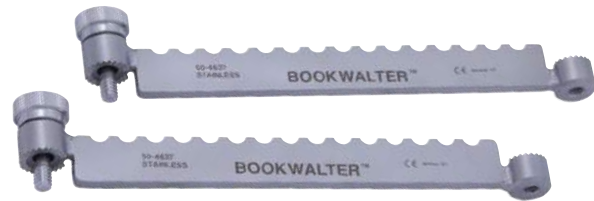

50-4637

### Bookwalter® Segmented Ring (Straight Segments)

CODE	DESCRIPTION	LENGTH
50-4636	Straight Ring Segment (Pair)	4 in 102 mm
50-4637	Straight Ring Segment (Pair)	6 in 152 mm
50-4638	Straight Ring Segment (Pair)	8 in 203 mm

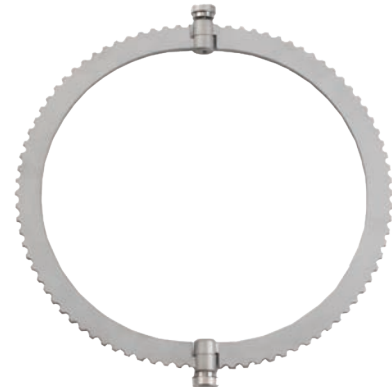

### Bookwalter® Universal Ring Segmented Ring Screw

CODE	DESCRIPTION	LENGTH
58-0093X	Screw Only, One Each	15/16 in 24 mm

## Abdominal (Bookwalter® Table Posts)



### Bookwalter® Post Holder

CODE	DESCRIPTION	LENGTH
50-4680	For Use with the Gooseneck 50-4681	4 in 102 mm



### Bookwalter® Table Post

CODE	LENGTH
50-4581	12 in 304 mm

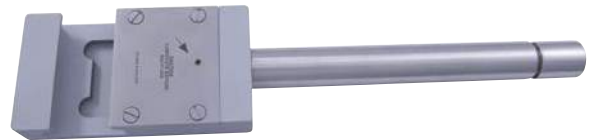

### Bookwalter® Table Post

CODE	LENGTH
50-4683	8 in 203 mm

### Bookwalter® Table Post

CODE	LENGTH
BW0144003	24 in 608 mm



### Bookwalter® Table Post

CODE	LENGTH
BW0144005	18 in 457 mm

## Abdominal (Bookwalter® Table Posts)

### Bookwalter® Lightweight Table Post

CODE	LENGTH	
50-4688	12 in	304 mm
50-4697	16 in	406 mm



504688

## Abdominal (Universal Blades)

### Universal Ring Big Boy Retractor Blade

CODE	DESCRIPTION	LENGTH
58-0020	Fenestrated	2 x 6 ½ in
58-0021	Fenestrated	3 x 6 ½ in



58-0021

### Universal Ring Deaver Retractor Blade

CODE	DESCRIPTION	DIMENSIONS	
58-0103		1 x 3 ½ in	25 x 89 mm
58-0104		1 x 5 in	25 x 127 mm
58-0102		2 x 6 ½ in	51 x 165 mm
58-0104T	Titanium	2/3 x 2 ¼ in	16.9 x 57 mm
58-0103T	Titanium	1 x 5 in	25 x 127 mm
58-0101T	Titanium	2 x 3 ½ in	51 x 89 mm
58-0102T	Titanium	3 x 6 ½ in	76 x 165 mm



58-101T

### Universal Ring Harrington Retractor Blade

CODE	DIMENSIONS	
58-0035	2/3 x 2 ¼ in	16.9 x 57 mm
58-0037	3 x 10 ½ in	76 x 267 mm



58-0035

## Abdominal (Bookwalter® Kits)

### Bookwalter® Retractor Kit III

CODE	NAME	QTY
50-5710	Bookwalter® Retractor Kit III Includes Following Items:	
50-4688	Bookwalter® Lightweight Table Post, 12 in	1
50-4554	Bookwalter® Post Coupler,	1
50-4582	Bookwalter® Lightweight Horizontal Flex Bar	1
50-4583	Bookwalter® Medium Segmented Ring	1
50-4636	Bookwalter® Straight Ring Segment, 4 in, Pair	1
50-4580	Bookwalter® Tilting Ratchet	4
50-4686	Bookwalter® Self-Retaining Tilting Ratchet	4
50-4568	Bookwalter® 2x3 Kelly Retractor Blade	2
50-4569	Bookwalter® 2x4 Kelly Retractor Blade	2
50-4570	Bookwalter® 2x5 Kelly Retractor Blade	1
50-4571	Bookwalter® 2x6 Kelly Retractor Blade	1
50-4566	Bookwalter® Harrington Retractor Blade	1
50-4577	Bookwalter® Balfour Retractor	1
50-4672	Bookwalter® 1½x6 Malleable Retractor Blade	1
50-4673	Bookwalter® 2x6 Malleable Retractor Blade	2
50-4674	Bookwalter® 3x6 Malleable Retractor Blade	1
BW033015	Bookwalter® Twister Ratchet	1

## Abdominal (Bookwalter® Kits)

### Bookwalter® III Obese Patient Kit

CODE	NAME	QTY
50-5720	Bookwalter® III Obese Patient Kit Includes Following Items:	
50-4697	Bookwalter® Lightweight Table Post, 16 in	1
50-4554	Bookwalter® Post Coupling	2
50-4553	Bookwalter® Lightweight Extension Bar, 12 in	1
50-4618	Bookwalter® Lightweight Horizontal Bar	1
50-4588	Bookwalter® Large Segmented Ring	1
50-4636	Bookwalter® Straight Ring Segment, 4 in, Pair	1
50-4637	Bookwalter® Straight Ring Segment, 6 in, Pair	1
50-4580	Bookwalter® Tilting Ratchet	4
50-4686	Bookwalter® Self-Retaining Tilting Ratchet	6
50-4571	Bookwalter® 2x6 Kelly Retractor Blade	2
BW1045000	Bookwalter® 2x8 Kelly Retractor Blade	2
BW1045176	Bookwalter® Harrington Retractor Blade	1
BW1271017	Bookwalter® Balfour Retractor	1
67-7502	Bookwalter® 1½ x 11 Opti-Length® Malleable Retractor Blade with Malleable Lip	1
67-7504	Bookwalter® 2 x 11 Opti-Length® Malleable Retractor Blade with Malleable Lip	1
67-7499	Bookwalter® 3 x 11 Opti-Length® Malleable Retractor Blade with Malleable Lip	1
67-7500	Bookwalter® 4 x 11 Opti-Length® Malleable Retractor Blade with Malleable Lip	1
BW0338014	Bookwalter® Ratchet Extender	2
BW0338015	Bookwalter® Twister Ratchet	1

## Abdominal (Kits)

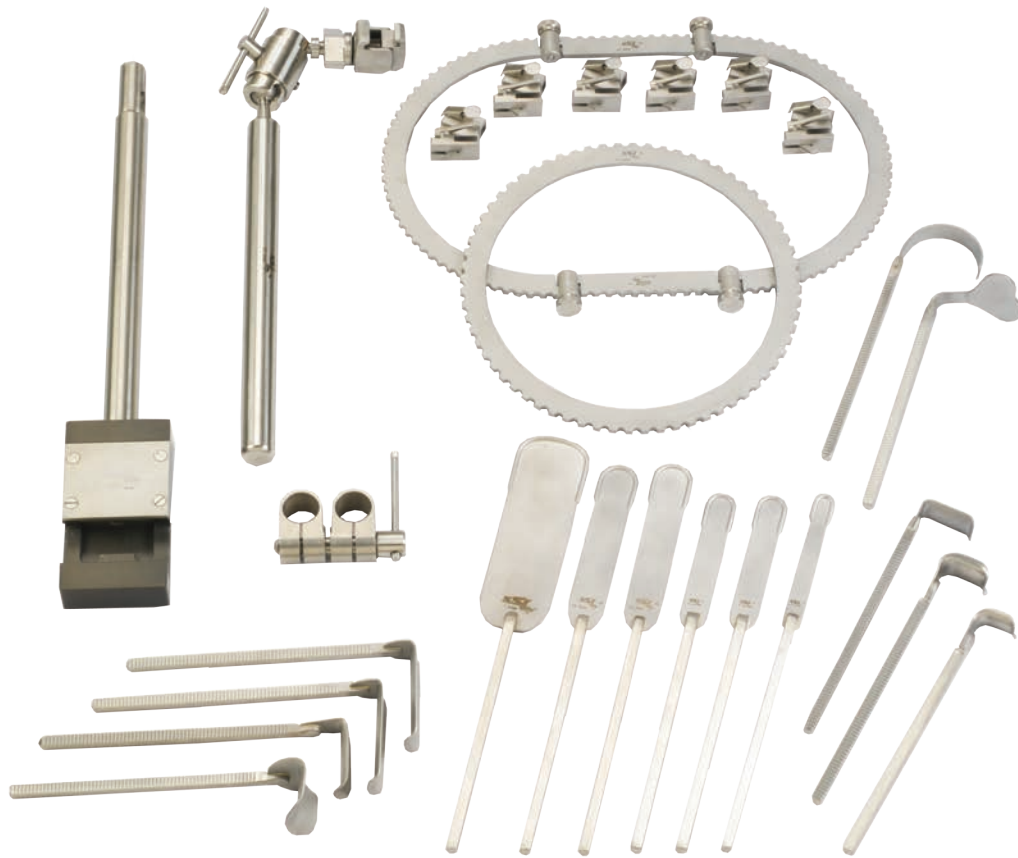

## Universal Ring Pediatric System

CODE	DESCRIPTION	LENGTH	QUANTITY
58-0145	Ring Pediatric System		
58-0001	12 in (305 mm) Table Post		1
58-0003	Post Coupling		1
58-0005	Horizontal Flex Bar		1
58-0065	Tilt Ratchets		6
58-0062	Small Round Ring		1
58-0058S	Small Segmented Ring		1
58-4501	Richardson Blade	$\frac{3}{4} \times 1$ in	1
58-4502	Richardson Blade	$\frac{3}{4} \times 1\frac{1}{4}$ in	1
58-0029	Kelly Blade	$1 \times 1\frac{1}{2}$ in	1
58-0027	Kelly Blade	$2 \times 1\frac{1}{2}$ in	1
58-0009	Kelly Blade	$1 \times 3$ in	2
58-0044	Malleable Blade	$2 \times 6$ in	1
58-0041	Malleable Blade	$\frac{1}{2} \times 4$ in	2
58-0042	Malleable Blade	$1 \times 5$ in	2
58-0040	Malleable Blade	$\frac{3}{4} \times 4$ in	1
58-0036	Baby Harrington	$\frac{1}{2} \times 2\frac{1}{2} \times 2$ in	1
58-0103	Deaver Blade	$\frac{2}{3} \times 2\frac{1}{4}$ in	1

## Abdominal (Universal Blades)

### Universal Ring Kelly Retractor Blade

CODE	DESCRIPTION	DIMENSIONS	
58-0025		1x3 in	51x76 mm
58-0018A	Aluminum	2x5 in	51x127 mm
58-0016A	Aluminum	2x6 in	51x152 mm
58-0032A	Aluminum	2x6 in	51x152 mm
58-0009		2½x5x3½ in	64x127x89 mm
58-0017T	Titanium	2½x8x3½ in	64x203x89 mm
58-0016T	Titanium	3x10½ in	76x267 mm

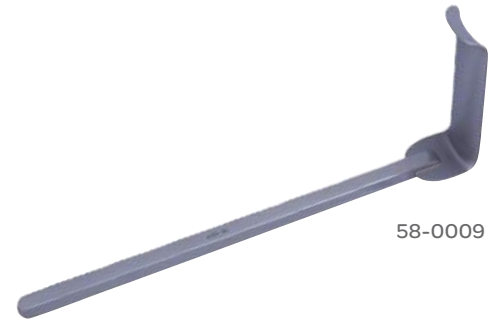

58-0009

### Universal Ring Meyering Retractor Blade

Without Teeth

CODE	DESCRIPTION	DIMENSIONS	
58-0048T	Titanium	2x4 in	51x102 mm
58-0051T	Titanium	2½x3 in	64x76 mm



58-0048T

### Universal Ring Pediatric Harrington Retractor Blade

CODE	DESCRIPTION	DIMENSIONS	
58-0036	Ring Pediatric Harrington Retractor Blade	2x8 in	51x203 mm

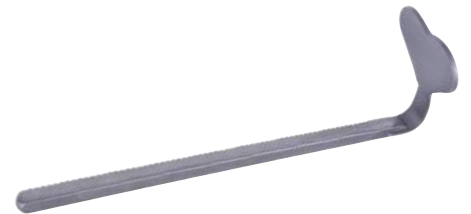

### Universal Ring Retractor Blade

CODE	DESCRIPTION	DIMENSIONS	
58-0073	Fence, Rigid	2x3¾ in	51x95 mm
58-0044T	Titanium	3½x3¾ in	89x95 mm

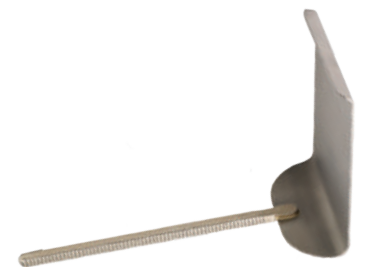

58-0073



## Abdominal (Universal Blades)

### Universal Ring Scoville Retractor Blade

CODE	DESCRIPTION
58-0106	Large



### Universal Ring Yu-Holtgrew Retractor Blade

CODE	DESCRIPTION	DIMENSIONS	
58-0022	Rigid	4 x 5 in	102 x 127 mm

### Universal Ring Retractor Blade

CODE	DESCRIPTION	LENGTH	
58-0042	Malleable, With Lip	1 x 5 in	25 x 127 mm
58-0045	Malleable, With Lip	2 x 8 in	51 x 203 mm
58-0049	Malleable, With Lip	1 x 5 in	25 x 127 mm
58-0054	Malleable, With Lip	6 x 9 in	152 x 228 mm
58-0056	Malleable, With Lip	4 x 10 in	102 x 254 mm



### Universal Ring Retractor Blade

CODE	DESCRIPTION	LENGTH	
58-0057N	Malleable, No Lip	6 x 9 in	152 x 229 mm
58-0044N	Malleable, No Lip	6 x 12 in	152 x 305 mm



## Abdominal (Vision)

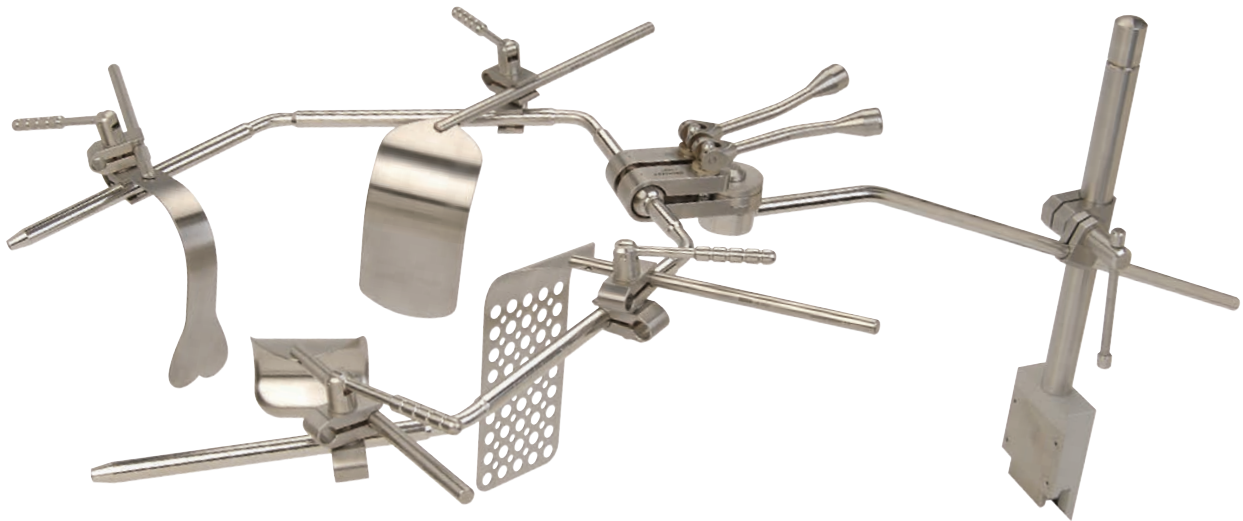

### Vision Retractor System

CODE	DESCRIPTION	DIMENSIONS		QTY
59-8850	Includes the Following Items:			
59-8802	Table Clamp with Vertical Post			1
59-8803	Retractor Clamp			6
59-8805	Vision Frame			1
59-8807	Mayo Swivel	2 3/4 x 2 in	70 x 51 mm	2
59-8809	Deaver Swivel	2 3/4 x 4 1/2 in	70 x 114 mm	1
59-8811	Harrington "Sweetheart"	2 x 5 in	51 x 127 mm	1
59-8813	Kelly Swivel "Modified"	3 x 2 1/2 in	76 x 64 mm	1
59-8814	Kelly Swivel "Modified"	3 x 4 in	76 x 102 mm	1
59-8815	Malleable Swivel, Perforated	2 x 6 in	51 x 152 mm	1
59-8816	Malleable Swivel, Perforated	3 x 6 1/2 in	76 x 165 mm	1
59-8818	Fence Swivel, Perforated	4 x 6 in	102 x 152 mm	1
59-8821	Splanchnic Swivel	2 x 6 in	51 x 152 mm	1
59-8801	Post Coupling			1
59-8828	Sterilization Case			1

### Symmetry Surgical Instrument Repair Services

#### KEY BENEFITS:

- Full instrument restoration
- 24-Hour turnaround for emergency repairs are available by request, but must be scheduled with our repair department and noted on the repair request form
- Free quotes
- Free evaluations

Questions about requesting a repair? Send it to [repairs@symmetrysurgical.com](mailto:repairs@symmetrysurgical.com). Our Repair Centers honor the warranties on all of our products. Customer satisfaction is our top priority!

## Appendectomy



### Richardson Appendectomy Retractor

CODE	DESCRIPTION	DIMENSIONS (W X D)	LENGTH
50-4131	Ring-Grip Handle	$\frac{3}{4}$ x 2 in 19 x 51 mm	9 $\frac{1}{4}$ in 235 mm



### Richardson Appendectomy Retractor

CODE	DESCRIPTION	DIMENSIONS (W X D)	LENGTH
50-4130C	Standard Handle	$1\frac{3}{16}$ x 2 in 20 x 51 mm	9 $\frac{1}{4}$ in 235 mm

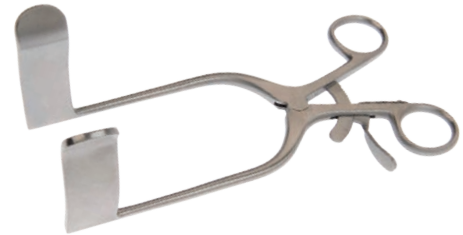

### Rigby Appendectomy Retractor

CODE	DESCRIPTION	LENGTH
24-4218	Appendectomy Retractor	7 $\frac{1}{2}$ in 190mm

## Cardiac (Aorta)

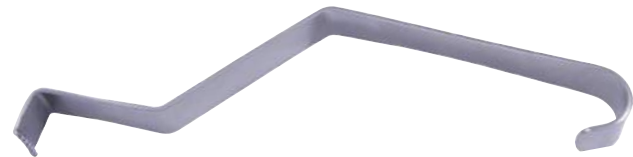

### Crawford Aorta Retractor

55-8008

CODE	DESCRIPTION	LENGTH
55-8008	Small	7 $\frac{1}{2}$ in 191 mm
55-8009	Large	12 in 305 mm

## Cardiac (Aortic Valves)



Liddicoat Aortic Valve Retractor

50-8012

CODE	DESCRIPTION	LENGTH
50-8011	Small	9½ in 241 mm
50-8012	Large	9½ in 241 mm

## Cardiac (Atrial)



50-8006

Cooley Atrial Retractor

CODE	DESCRIPTION	LENGTH
50-8006	Right	10 in 254 mm
50-8005	Left	12 in 305 mm



Cooley Atrial Retractor

CODE	DESCRIPTION	DIMENSIONS
50-8007	Modified with Teeth	1¾ x 1¾ in 44 x 44 mm

## Cardiac (Atrial Valves)



50-8005

Cooley Atrial Valve Retractor

CODE	DESCRIPTION	DIMENSIONS (W X D)
55-8005	Left	2 x ¾ in 50 x 10 mm
55-8001	Right, Small	1 x ¾ in 25 x 20 mm
55-8002	Right, Medium	1 ⅝ x 1 ⅛ in 40 x 30 mm
55-8003	Right, Large	2 x 1 ⅜ in 50 x 35 mm

## Cardiac (Epicardial)

### I.M.A. Epicardial Retractor (Gold Coated)

CODE	DESCRIPTION	LENGTH
80-1864	Mini	1 in 25 mm
80-1861	Small	1 1/8 in 28 mm
80-1862	Medium	1 1/2 in 38 mm
80-1863	Large	2 1/8 in 54 mm

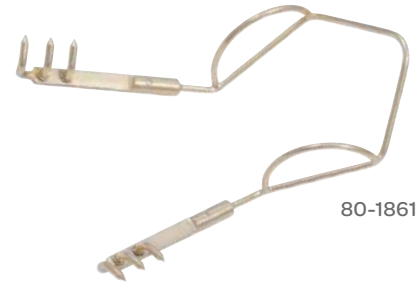

80-1861

### Parsonnet Epicardial Retractor

3 x 3 Prong, Sharp

CODE	DESCRIPTION	LENGTH
37-4035	Self-Retaining, Light Spring Steel	1 1/2 in 38 mm
55-5750	Small	1 1/8 in 29 mm
55-5751	Medium	1 7/16 in 37 mm
55-5752	Large	1 7/8 in 47 mm

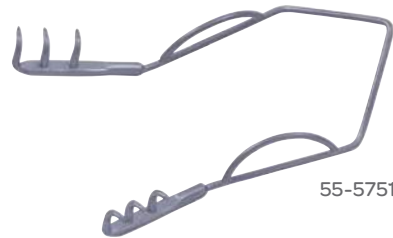

55-5751

## Cardiac (Bookwalter®)

### Bookwalter® I.M.A. Crossbar

CODE	DESCRIPTION	DIMENSIONS
50-4601	Small	1 1/8 in 29 mm
50-4675	"T" bar for Use with the BW I.M.A. Kit 50-4600	



50-4675

### Bookwalter® I.M.A. Retractor Blade

CODE	DESCRIPTION	LENGTH
50-4603	I.M.A Retractor Blade	12 in 304 mm



## Cardiac (Bookwalter®)

### Bookwalter® I.M.A. Retractor Storage Case

CODE	DESCRIPTION
50-4604	I.M.A. Retractor Storage Case



### Bookwalter® I.M.A. Ratchet

CODE	DESCRIPTION
50-4602	I.M.A. Ratchet



### Bookwalter® I.M.A. Retractor System

Provides the Tools to Elevate and Retract the Sternum for Efficient Dissection of the Internal Mammary Art

CODE	DESCRIPTION	LENGTH	QTY
50-4600	Includes Part Numbers Listed Below:		
50-4552	Horizontal Bar	14 ¼ in 365 mm	1
50-4554	Coupler	1 x 1 in 25 x 25 mm	1
50-4581	Table Post	12 in 305 mm	1
50-4601	I.M.A. Cross Bar	12 in 305 mm	1
50-4602	I.M.A. Ratchet		2
50-4603	I.M.A. Rake Retractor, Sharp		2
50-4604	I.M.A. Retractor Case		1

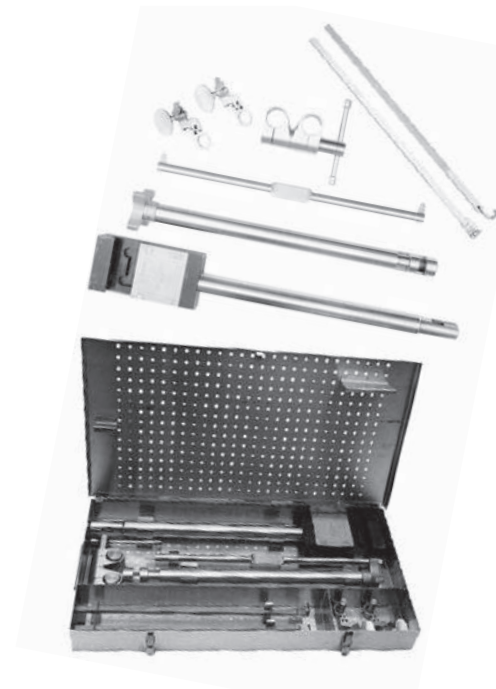

## Carotid (Self-Retaining)



55-9050

### Henly Carotid Retractor

Modified Weitlaner with Three Center Blades

CODE	DESCRIPTION	DIMENSIONS (D X W)	
55-9050	Complete Set		
55-9051	6½ in Long		
55-9052	Small Blade For 55-9050	¾ x ⅝ in	19 x 16 mm
55-9053	Medium Blade for 55-9050	1 x ⅝ in	25 x 16 mm
55-9054	Large Blade for 55-9050	1¼ x ⅝ in	32 x 16 mm



### Henly Self-Retaining Carotid Retractor

CODE	DESCRIPTION	DIMENSIONS (D X W)	
55-8999	Set with 3 Removable Side Blades and 3 Removable Center Blades		
55-8999A	Frame Only for 55-8999, 2⅜ in 61 mm Spread	¾ x ⅝ in	19 x 16 mm
55-8999-1	Side Blade	1 x ⅞ in	25 x 23 mm
55-8999-2	Side Blade	2 x ⅞ in	51 x 23 mm
55-8999-3	Side Blade	3 x ⅞ in	76 x 23 mm
55-8999-4		¾ x ⅝ in	19 x 16 mm
55-8999-5		1 x ⅝ in	25 x 16 mm
55-8999-6		1¼ x ⅝ in	31 x 16 mm
55-8999-7		3 x ⅝ in	76 x 16 mm
55-8999-8		2 x ⅝ in	51 x 16 mm

## Cerebellar

### Adson Cerebellar Retractor

Length: 7 <sup>3</sup>/<sub>4</sub> in (197 mm)

CODE	DESCRIPTION	PRONGS
24-2801	Straight Arms	4 x 4, Sharp
24-2803	Straight Arms	4 x 4, Sharp
50-1180	Straight Shaft	4 x 4, Sharp
50-1182	Straight Shaft	4 x 4, Sharp
24-2802	Angled Arms	4 x 4, Sharp
50-1181	Angular Shaft	4 x 4, Sharp
50-1362	65° Shank Angle	4 x 4, Sharp



24-2801

### Malis® Cerebellar Retractor

CODE	DESCRIPTION	PRONGS	DIMENSIONS
50-1465	Self Retaining, Angular Arms	4 x 4, Sharp	7 <sup>1</sup> / <sub>2</sub> in 191 mm

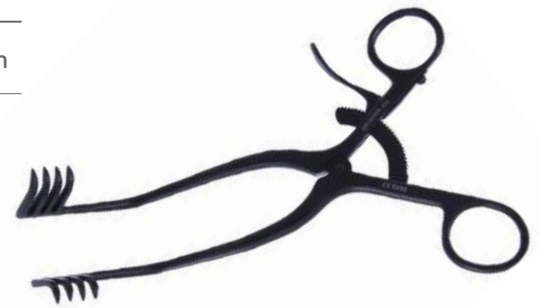

### Miskimon Cerebellar Retractor

Sharp

CODE	DESCRIPTION	PRONGS	LENGTH
50-1363		7 x 7	7 <sup>1</sup> / <sub>2</sub> in 191 mm
24-2810	Angled Arms	7 x 7	8 <sup>3</sup> / <sub>4</sub> in 222 mm



## Cheek

### Cheek Retractor

CODE	DESCRIPTION	DIMENSIONS (W X L)
72-0240	With Swivel	1 <sup>11</sup> / <sub>16</sub> x 8 <sup>3</sup> / <sub>16</sub> in 43 x 209 mm





## Deltoid



### Deltoid Retractor

CODE	DESCRIPTION	BLADE	LENGTH
77-1015	Brown Deltoid Retractor	2 <sup>3</sup> / <sub>8</sub> x 2 <sup>9</sup> / <sub>16</sub> in 60 x 65 mm	10 <sup>7</sup> / <sub>8</sub> in 275 mm

## Endaural



### Endaural Retractor

CODE	DESCRIPTION
61-0601	T Model



### Snitman Endaural Retractor

CODE	DESCRIPTION	PRONGS	LENGTH
50-1236	Self-Retaining	9/ <sub>16</sub> x 3/ <sub>8</sub> 14 x 10 mm	4 <sup>3</sup> / <sub>16</sub> in 106 mm

## ENT(Mastoid)

## Miskimon Cerebellar Retractor

7 x 7 Prongs, Sharp, Angled Arms

CODE	BLADE DEPTH	LENGTH
24-2810	1¼ in 32 mm	8¾ in 222 mm



## ENT(Nasal)

## Aufricht Nasal Retractor

CODE	LENGTH
67-2136	7⅞ in 182 mm
67-2135	7½ in 191 mm

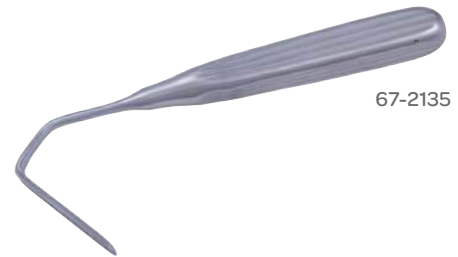

## Converse Nasal Retractor

CODE	LENGTH
63-4022	4¾ in 112 mm



## Cottle Nasal Retractor

CODE	PRONGS	LENGTH
67-2044	4, Blunt	5⅞ in 130 mm

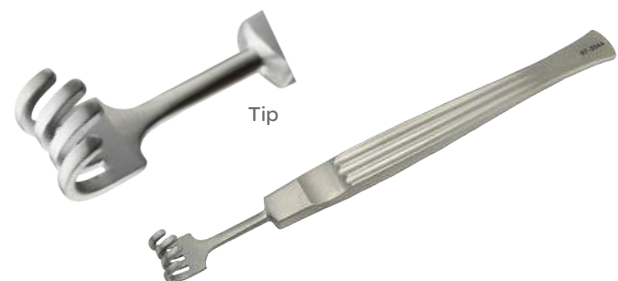

## ENT (Nasal)



### Halle Nasal Speculum

CODE	BLADE LENGTH	TOTAL LENGTH
79-6669	1 ¼ in 32 mm	6 in 152 mm



### Vienna Nasal Speculum

CODE	BLADE LENGTH	TOTAL LENGTH
79-6675	1 in 25 mm	5 ¼ in 133 mm

## Fiber Optic



67-2399FS

### Ferreira Style Retractor

With Fiber Optic Light Guide and Suction, Smooth Tip

CODE	DIMENSIONS (D X W)
67-2338FS	14 x 90 mm
67-2121FS	16 x 80 mm
67-2340FS	16 x 150 mm
67-2512FS	25 x 120 mm
67-2339FS	25 x 150 mm
67-2331FS	25 x 190 mm

## Fiber Optic



## Tebbetts Style Retractor

Serrated Tip, with Fiber Optic Light Guide and Suction

67-2423FS

CODE	DESCRIPTION	BLADE LENGTH
67-2422FS	24 x 90 mm	4 in 100 mm
67-2420FS	24 x 100 mm	4 in 100 mm
67-2425FS	25 x 100 mm	4 in 100 mm
67-2427FS	23 x 150 mm	4 in 100 mm
67-2121FS	16 x 80 mm	
67-2229FS	30 x 90 mm	
67-2230FS	30 x 100 mm	
67-2231FS	30 x 150 mm	
67-2423FS	36 x 190 mm	

## Gall Bladders



## Foss Gall Bladder Retractor

CODE	DESCRIPTION	DIMENSIONS
23-6300	Gall Bladder Retractor	1¾ x 14½ in 44 x 368 mm



## Murphy Gall Bladder Retractor

23-6292

CODE	TOTAL LENGTH	BLADE WIDTH
23-6290	11 in 279 mm	1¾ in 44 mm
23-6292	11 in 279 mm	2 in 51 mm

## General Purpose (Finger Retractors)



Meyerding Finger Retractor

50-1070

CODE	DESCRIPTION	DIMENSIONS	
50-1070	A	7 $\frac{1}{8}$ in	181 mm
50-1071	B	7 in	178 mm
50-1072	C	7 in	178 mm
50-1073	D	7 in	178 mm
50-1074	E	7 in	178 mm
50-1075	F	7 in	178 mm

Meyerding Finger Retractor



CODE	DESCRIPTION	DIMENSIONS	
50-4485	Double-Ended, with Skin Hook	7 in	178 mm

Meyerding Finger Retractor



20-1001

CODE	DESCRIPTION	DIMENSIONS	
20-1001	#1		
20-1002	#2	7 $\frac{1}{8}$ in	181 mm
20-1003	#3	7 $\frac{1}{8}$ in	181 mm
20-1004	#4	7 $\frac{1}{8}$ in	181 mm
20-1005	#5	7 $\frac{1}{8}$ in	181 mm
20-1006	#6	7 $\frac{1}{8}$ in	181 mm



Volkman Finger Retractor

22-2603

CODE	DESCRIPTION	LENGTH	
22-2602	2 Prong, Sharp	4 $\frac{1}{8}$ in	105 mm
22-2603	3 Prong, Sharp	4 $\frac{1}{8}$ in	105 mm
22-2604	4 Prong, Sharp	4 $\frac{1}{8}$ in	105 mm
22-2606	6 Prong, Sharp	4 $\frac{1}{8}$ in	105 mm
22-2702	2 Prong, Blunt	4 $\frac{1}{8}$ in	105 mm
22-2703	3 Prong, Blunt	4 $\frac{1}{8}$ in	105 mm
22-2704	4 Prong, Blunt	4 $\frac{1}{8}$ in	105 mm
22-2706	6 Prong, Blunt	4 $\frac{1}{8}$ in	105 mm

## General Purpose (Hand-Held)

### Deaver Pediatric Retractor

Flexible



23-7217

CODE	WIDTH	DIMENSIONS	
23-7217	17 mm	8 in	203 mm
23-7225	25 mm	8 in	203 mm



22-1015

### Farabeuf Pediatric Retractor

CODE	DESCRIPTION	DIMENSIONS	
22-1012	Double-Ended, Set of 2	4 $\frac{7}{8}$ in	124 mm
22-1015	Double-Ended, Set of 2	6 in	152 mm



### B.E. Glass Abdominal Retractor

CODE	DESCRIPTION	WIDTH	LENGTH	TOTAL LENGTH
24-3380	Abdominal Retractor	3 $\frac{1}{4}$ in 85 mm	6 in 155 mm	9 $\frac{3}{4}$ in 245 mm



### Blair (Rollet) Retractor

CODE	DESCRIPTION	WIDTH	LENGTH
63-4010	4 Prong, Sharp	6 mm	5 $\frac{1}{4}$ in 133 mm

## General Purpose (Hand-Held)

### Boley Retractor



CODE	DESCRIPTION	BLADES (W X D)	LENGTH
50-5608	#1, Double-Ended	$\frac{1}{2} \times \frac{1}{2}$ in $\frac{7}{16} \times \frac{7}{16}$ in	$6 \frac{1}{4}$ in 159 mm

### Children's Hospital Retractor



CODE	DESCRIPTION	BLADE (W X D)	LENGTH
50-4100	Small, Double-Ended	$\frac{7}{16} \times \frac{7}{8}$ in $\frac{9}{16} \times 1 \frac{3}{8}$ in	$5 \frac{1}{2}$ in 140 mm

### Children's Hospital Retractor



CODE	DESCRIPTION	BLADE (W X D)	LENGTH
50-5645	S-Shaped, Double-Ended	$\frac{1}{4} \times \frac{3}{4}$ in $\frac{1}{2} \times \frac{3}{4}$ in	$4 \frac{7}{8}$ in 124 mm

### Collins Retractor



CODE	DESCRIPTION	LENGTH	QTY
22-1215	Double-Ended	$6 \frac{1}{2}$ in 165 mm	Set of 2

### Converse Alar Retractor

10 mm and 14 mm wide



CODE	DESCRIPTION	LENGTH
67-2010	Double-Ended, Sharp	$4 \frac{3}{4}$ in 120 mm

## General Purpose (Hand-Held)



### Cottle Alar Retractor

CODE	DESCRIPTION	LENGTH
67-2115	Tapered End, 16–13 mm	6½ in 165 mm



Tip



67-2021

### Cottle Retractor

Double Prong, One Ball Tip

CODE	DESCRIPTION	LENGTH
67-2021	Right Prong Sharp	5⅞ in 149 mm
67-2022	Left Prong Sharp	5⅞ in 149 mm



### Cottle Tenaculum Hook

CODE	DESCRIPTION	DIMENSIONS
20-4016	Angled	6½ in 160 mm



### Cottle-Neivert Retractor

CODE	DESCRIPTION	WIDTH	LENGTH
67-2052	Double-Ended, 2 Prong, Blunt	10 mm	8¼ in 209 mm



20-0930

### Crile Retractor

CODE	DESCRIPTION	LENGTH
20-0930	Double-Ended	4½ in 108 mm
50-4105	Double-Ended	4½ in 108 mm



## General Purpose (Hand-Held)



32-3633

### Cushing Retractor

CODE	JAW LENGTH	LENGTH	CODE	JAW LENGTH	LENGTH
32-3633	10 mm	11 in 279 mm	32-3634	11 mm	14 in 356 mm



### Darrach Retractor

CODE	DESCRIPTION	WIDTH	LENGTH
77-6005	Retractor	9 mm	10¼ in 260 mm



50-4316

### Deaver Abdominal Retractor

CODE	HANDLE	LENGTH
50-4316	#1 Ring Grip	12 in 304 mm
50-4317	#2 Ring Grip	13 in 330 mm
50-4319	#3 Ring Grip	12 in 304 mm
50-4320	#4 Ring Grip	12 in 304 mm
50-4321	#5 Ring Grip	12 in 304 mm



### Deaver Retractor

CODE	DESCRIPTION	DIMENSIONS (W X D)
23-7522	Hollow Handle	2½ x 4 in 64 x 100 mm

## General Purpose (Hand-Held)



50-4307

### Deaver Retractor

Standard Handle

CODE	DESCRIPTION	WIDTH		LENGTH	
50-4303	#1	1 in	25 mm	12 in	305 mm
50-4304	#2	1 in	25 mm	12 in	305 mm
50-4306	#3	1½ in	38 mm	12 in	305 mm
50-4307	#4	2 in	51 mm	12 in	305 mm
50-4308	#5	3 in	76 mm	12 in	305 mm



23-7211

### Deaver Retractor

CODE	DESCRIPTION	WIDTH		LENGTH	
23-7211	Ring-Grip Handle	1 in	25 mm	12 in	305 mm
23-7212	Ring-Grip Handle	1 in	25 mm	12 in	305 mm
23-7213	Ring-Grip Handle	1½ in	38 mm	12 in	305 mm
23-7214	Ring-Grip Handle	2 in	51 mm	12 in	305 mm
23-7215	Ring-Grip Handle	3 in	76 mm	12 in	305 mm
23-7216	Ring-Grip Handle	4 in	102 mm	12 in	305 mm
23-7218	Ring-Grip Handle	2 in	51 mm	15 in	305 mm
23-7221	Ring-Grip Handle	1 in	25 mm	16 in	405 mm



### Deaver Abdominal Retractor

CODE	DESCRIPTION	DIMENSIONS	
23-7244	Abdominal Retractor	1x10 in	25x254 mm

## General Purpose (Hand-Held)



50-4307

### Deaver Retractor

Standard Handle

CODE	DESCRIPTION	WIDTH		LENGTH	
50-4303	#1	1 in	25 mm	12 in	305 mm
50-4304	#2	1 in	25 mm	12 in	305 mm
50-4306	#3	1½ in	38 mm	12 in	305 mm
50-4307	#4	2 in	51 mm	12 in	305 mm
50-4308	#5	3 in	76 mm	12 in	305 mm

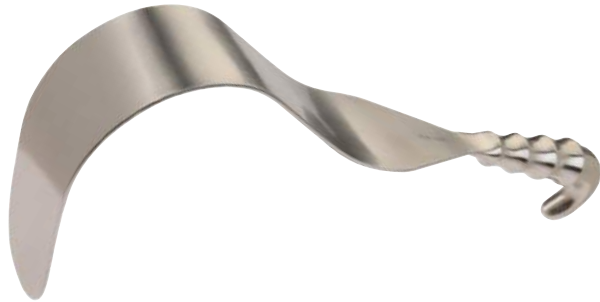

### Deaver Abdominal Retractor

CODE	BLADE LENGTH	HANDLE LENGTH	
32-3635	2½ in (640 mm)	14½ in	368 mm

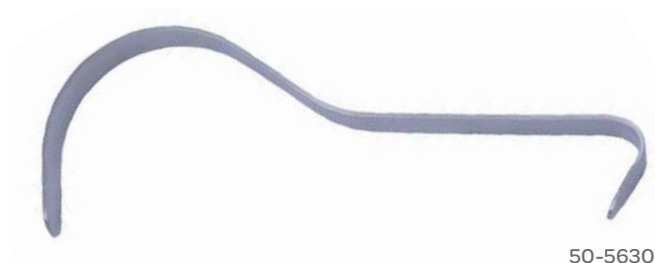

50-5630

### Deaver Abdominal Retractor

CODE	DEPTH		WIDTH		DIMENSIONS	
50-5629	2½ in	63 mm	¾ in	10 mm	8 in	203 mm
50-5630	2½ in	63 mm	⅝ in	15 mm	8 in	203 mm
50-5631	2½ in	63 mm	1 in	25 mm	8 in	203 mm

## General Purpose (Hand-Held)



### Delee Universal Retractor

CODE	LENGTH
52-2340	9½ in 241 mm
50-5575	9½ in 241 mm



20-6453

### Flexible Neck Retractor

CODE	DESCRIPTION	LENGTH	CODE	DESCRIPTION	LENGTH
20-6452	2 Prong, Sharp	6¼ in 159 mm	20-6552	2 Prong, Blunt	6¼ in 159 mm
20-6453	3 Prong, Sharp	6¼ in 159 mm	20-6553	3 Prong, Blunt	6¼ in 159 mm



### Fomon Hook Retractor

CODE	DESCRIPTION	TIP WIDTH	LENGTH	DIMENSIONS
67-2025	Both Prong Ball Tipped	13 mm	6¾ in 171 mm	10¼ x 2 x 2½ in 260 x 51 x 64 mm



22-2001

### Freeman Rake Retractor

CODE	WIDTH	LENGTH
22-2001	1½ in 38 mm	7 in 178 mm
22-2004	¾ in 22 mm	7 in 178 mm

## General Purpose (Hand-Held)



23-3752

### Goelet General Purpose Retractor

CODE	DESCRIPTION	DIMENSIONS	
50-4095	Double-Ended	7 ½ in	191 mm
23-3752	Double-Ended	7 ½ in	191 mm



### Gorney Rake Spring Neck Retractor

CODE	DESCRIPTION	LENGTH	
20-2011	4 Prong, Sharp	3 in	76 mm



23-6381

### Hibbs Retractor

CODE	DESCRIPTION	DIMENSIONS (W X D)		DIMENSIONS	
23-6381	Sharp Teeth	1 x 3 in	25 x 76 mm	9 in	228 mm
23-6382	Sharp Teeth	1 x 3 ¼ in	25 x 82 mm	9 in	228 mm
50-2558C	Double Ended, Set of 2	¾ x 2 in	19 x 51 mm	9 ¼ in	235 mm



22-7204

### Israel Retractor

CODE	DESCRIPTION	PRONGS	BLADES (W X D)		LENGTH	
50-4246	Blunt	4 Prong	1 ¾ x 1 ¾ in	44 x 44 mm	7 ¾ in	197 mm
22-7204	Blunt	4 Prong	1 ½ x 1 ½ in	38 x 38 mm	10 in	254 mm
22-7205	Blunt	5 Prong	2 x 1 ¾ in	51 x 44 mm	10 in	254 mm
22-7206	Blunt	6 Prong	2 ¾ x 2 in	60 x 51 mm	10 in	254 mm

## General Purpose (Hand-Held)



23-4701

### Kelly Retractor

CODE	DESCRIPTION	BLADE (W X L)		LENGTH	
23-4701	Standard Handle	1½ x 2 in	35 x 51 mm	10¼ in	260 mm
23-4702	Standard Handle	2 x 2½ in	51 x 64 mm	10¼ in	260 mm
23-4703	Standard Handle	2½ x 3 in	64 x 76 mm	10¼ in	260 mm
23-4711	Lamb Handle	1¼ x 2 in	32 x 51 mm	10¼ in	260 mm
23-4712	Lamb Handle	2 x 2½ in	51 x 64 mm	10¼ in	260 mm
23-4713	Lamb Handle	2½ x 3 in	64 x 76 mm	10¼ in	260 mm
23-4714	Lamb Handle	3 x 3½ in	76 x 89 mm	10¼ in	260 mm
23-4715	Ring-Grip Handle	1½ x 2 in	38 x 51 mm	10¼ in	260 mm
23-4716	Ring-Grip Handle	2 x 2½ in	51 x 64 mm	10¼ in	260 mm
23-4717	Ring-Grip Handle	2½ x 3 in	63 x 76 mm	10¼ in	260 mm
23-4718	Ring-Grip Handle	3 x 3½ in	76 x 89 mm	10¼ in	260 mm



50-4117

### Kelly Retractor

Ring-Grip Handle

CODE	DESCRIPTION	BLADE (W X D)		LENGTH	
50-4115	Small	1½ x 2 in	38 x 51 mm	9¼ in	235 mm
50-4116	Medium	2 x 2½ in	51 x 64 mm	9¼ in	235 mm
50-4117	Large	2½ x 3 in	64 x 76 mm	10 in	254 mm
50-4118	XL	3 x 3½ in	76 x 89 mm	10 in	254 mm

### Kelly Retractor

Standard Handle

CODE	DESCRIPTION	BLADE (W X D)		LENGTH	
50-4110	Small	1½ x 2 in	38 x 51 mm	9¼ in	235 mm
50-4111	Medium	2 x 2½ in	51 x 64 mm	9½ in	241 mm
50-4112	Large	2½ x 3 in	64 x 76 mm	10 in	254 mm



50-4110

## General Purpose (Hand-Held)



### Knapp Retractor

20-5516

CODE	DESCRIPTION	PRONGS	WIDTH	LENGTH
20-5516	Sharp	4 Prong	6 mm	5 in 127 mm
20-5517	Blunt	4 Prong	6 mm	5 in 127 mm



### Langenbeck Retractor

23-0710

CODE	DESCRIPTION	BLADE (W X D)	LENGTH
23-0710	Hollow Handle	$\frac{3}{8}$ x $1\frac{1}{2}$ in 10 x 38 mm	8 $\frac{3}{4}$ in 222 mm
50-4255	#1	$\frac{3}{8}$ x $1\frac{5}{8}$ in 10 x 41 mm	8 $\frac{1}{4}$ in 210 mm
50-4256	#2	$\frac{1}{2}$ x $1\frac{5}{8}$ in 13 x 41 mm	8 $\frac{1}{4}$ in 210 mm
23-0713	Hollow Handle	$\frac{1}{2}$ x $1\frac{1}{16}$ in 13 x 43 mm	8 $\frac{3}{4}$ in 222 mm
23-0716	Hollow Handle	$\frac{5}{8}$ x $1\frac{1}{16}$ in 16 x 43 mm	8 $\frac{3}{4}$ in 222 mm



### Mathieu Retractor

3 Prong Blade, Double-Ended

50-4291

CODE	DESCRIPTION	PRONG WIDTH	DIMENSIONS (W X D)	TOTAL LENGTH
50-4291	Blunt	$\frac{3}{8}$ in 10 mm	$\frac{1}{4}$ x $\frac{3}{4}$ in 6 x 19 mm	5 $\frac{1}{8}$ in 20 mm
50-4290	Sharp	$\frac{3}{8}$ in 10 mm	$\frac{1}{4}$ x $\frac{3}{4}$ in 6 x 19 mm	6 $\frac{1}{2}$ in 165 mm



### Mathieu Retractor

23-6301

CODE	DESCRIPTION	PRONG WIDTH	BLADE WIDTH	BLADE DEPTH	LENGTH
50-4290	Double-Ended, 3 Prong, Sharp	$\frac{3}{8}$ in 10 mm	$\frac{1}{4}$ in 6 mm	$\frac{3}{4}$ in 19 mm	6 $\frac{1}{2}$ in 165 mm

## General Purpose (Hand-Held)

### Mayo Abdominal Retractor



CODE	LENGTH
23-6346 2¾ in 70 mm	10 in 254 mm

### Miller Rake Retractor

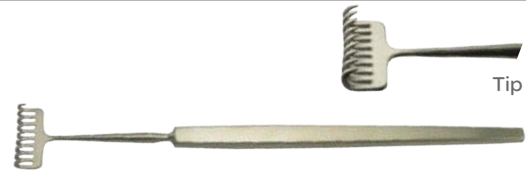

22-2043

CODE	DESCRIPTION	LENGTH
22-2043	9 Prong, Sharp	5¼ in 140 mm
22-2044	9 Prong, Blunt	5¼ in 140 mm

### Murphy Retractor



22-5004

CODE	DESCRIPTION	LENGTH
22-5004	4 Prong, Sharp	7¾ in 197 mm
50-8072	4 Prong, Sharp	7¾ in 197 mm
22-5006	6 Prong, Sharp	7¾ in 197 mm
22-5103	3 Prong, Blunt	7¾ in 197 mm
22-5104	4 Prong, Blunt	7¾ in 197 mm
22-5106	6 Prong, Blunt	7¾ in 197 mm

### Oldberg Retractor



57-5253

CODE	DESCRIPTION	TIP WIDTH	LENGTH
57-5250	Plain	9 mm	8¼ in 209 mm
57-5253	3 Prong	13 mm	8¼ in 209 mm
57-5254	4 Prong	15 mm	8¼ in 209 mm
57-5256	6 Prong	19 mm	8¼ in 209 mm



## General Purpose (Hand-Held)



67-2050

### Neivert Knife Guide & Retractor

CODE	DESCRIPTION	TIP WIDTH	LENGTH	DIMENSIONS
67-2051	Double-Ended with 2 Ball Tips	10 mm	7½ in 190 mm	6½ in 165 mm
67-2050	Double-Ended	10 mm	7½ in 190 mm	6½ in 165 mm



### Obwegeser Retractor

CODE	DESCRIPTION	DIMENSIONS	LENGTH
68-1006	Curved Down	¾ x 1¼ in 10 x 42 mm	8¾ in 222 mm



50-4253

### Ollier Retractor

CODE	DESCRIPTION	LENGTH
22-7002	4 Prong, Blunt	8½ in 216 mm
50-4253	4 Prong, Blunt	9 in 229 mm



50-4091

### Parker Retractor

Double-Ended

CODE	DESCRIPTION	LENGTH	QTY
22-1413	Small	5 in 127 mm	Set of 2
50-4090	Small	5½ in 140 mm	Set of 2
22-1418	Large	7 in 176 mm	Set of 2



### Parker Mott Retractor

CODE	DESCRIPTION	LENGTH	QTY
22-1516	Double-Ended	6½ in 166 mm	Set of 2

## General Purpose (Hand-Held)



### Pelvic Retractor

CODE	DESCRIPTION	TIP WIDTH	LENGTH
77-1014	Pelvic Retractor	24 mm	10 <sup>3</sup> / <sub>4</sub> in 273 mm



50-2608

### Ragnell Retractor

CODE	DESCRIPTION	BLADE (W X D)	LENGTH
50-2608	Double-Ended	$\frac{1}{8} \times \frac{1}{4}$ in 3 x 6 mm $\frac{1}{4} \times \frac{5}{8}$ in 6 x 16 mm	6 in 152 mm
20-0525	Double-Ended	$\frac{1}{8} \times \frac{1}{4}$ in 3 x 6 mm	6 in 152 mm
20-0526	Double-Ended	$\frac{1}{8} \times \frac{3}{16}$ in 3 x 5 mm	6 in 152 mm



### Rake Retractor

CODE	DESCRIPTION	LENGTH
22-5806	6 Prong, Sharp	9 <sup>1</sup> / <sub>2</sub> in 241 mm

### Ribbon Retractor

Double-Ended, Malleable



22-0006

CODE	WIDTH	LENGTH	CODE	WIDTH	LENGTH
22-0006	$\frac{1}{4}$ in 6 mm	8 in 203 mm	22-0253	$1\frac{1}{4}$ in 32 mm	13 in 330 mm
22-0012	$\frac{1}{2}$ in 13 mm	8 in 203 mm	22-0254	$1\frac{1}{2}$ in 38 mm	13 in 330 mm
22-0017	$\frac{5}{8}$ in 16 mm	8 in 203 mm	22-0255	2 in 51 mm	13 in 330 mm
22-0025	1 in 25 mm	8 in 203 mm	22-0256	$2\frac{1}{2}$ in 64 mm	13 in 330 mm
22-0027	1 in 25 mm	10 in 254 mm	22-0257	3 in 76 mm	13 in 330 mm
22-0035	$1\frac{3}{4}$ in 44 mm	10 in 254 mm	22-0258	4 in 102 mm	13 in 330 mm
22-0251	$\frac{3}{4}$ in 19 mm	13 in 330 mm	22-0259	5 in 127 mm	13 in 330 mm
22-0252	1 in 25 mm	13 in 330 mm			

## General Purpose (Hand-Held)



50-4212

### Ribbon Malleable Retractor

CODE	DESCRIPTION	BLADE WIDTH		LENGTH	
50-5637	Double-Ended	½ in	13 mm	8 in	203 mm
50-5639	Double-Ended	¾ in	19 mm	8 in	203 mm
50-4210	Double-Ended	1 in	25 mm	13 in	330 mm
50-4212	Double-Ended	1½ in	38 mm	13 in	330 mm
50-4214	Double-Ended	2 in	51 mm	13 in	330 mm



23-4501

### Richardson Retractor

CODE	DESCRIPTION	BLADE (W X D)		LENGTH	
23-4501	Standard Handle	¾ x 1 in	19 x 25 mm	9½ in	241 mm
23-4502	Standard Handle	1 x 1¼ in	25 x 32 mm	9½ in	241 mm
23-4503	Standard Handle	1½ x 1½ in	38 x 38 mm	9½ in	241 mm
23-4504	Standard Handle	¾ x 2 in	19 x 51 mm	9½ in	241 mm
23-4505	Standard Handle	1⅝ x 2½ in	41 x 64 mm	9½ in	241 mm



23-4514

### Richardson Retractor

CODE	DESCRIPTION	BLADE (W X D)		LENGTH	
23-4511	Lamb Handle	¾ x 1 in	19 x 25 mm	9½ in	241 mm
23-4512	Lamb Handle	1 x 1¼ in	25 x 32 mm	9½ in	241 mm
23-4514	Lamb Handle	¾ x 2 in	19 x 51 mm	9½ in	241 mm

## General Purpose (Hand-Held)



50-4122

### Richardson Retractor

CODE	DESCRIPTION	SIZE	BLADE (W X D)		LENGTH	
23-4515	Ring-Grip Handle	Small	$\frac{3}{4}$ x 1 in	19 x 25 mm	9 $\frac{1}{2}$ in	241 mm
23-4516	Ring-Grip Handle	Medium	1 x 1 $\frac{1}{4}$ in	25 x 32 mm	9 $\frac{1}{2}$ in	241 mm
23-4517	Ring-Grip Handle	Large	1 $\frac{1}{2}$ x 1 $\frac{1}{2}$ in	38 x 38 mm	9 $\frac{1}{2}$ in	241 mm
23-4518	Ring-Grip Handle	Small	$\frac{3}{4}$ in x 2 in	19 x 51 mm	9 $\frac{1}{2}$ in	241 mm
23-4520	Ring-Grip Handle	Medium	1 $\frac{3}{16}$ x 4 in	30 x 100 mm	9 $\frac{1}{2}$ in	241 mm
50-4120	Standard Handle	Small	$\frac{3}{4}$ x 1 in	19 x 25 mm	9 $\frac{1}{4}$ in	235 mm
50-4121	Standard Handle	Medium	1 x 1 $\frac{1}{4}$ in	25 x 32 mm	9 $\frac{1}{4}$ in	235 mm
50-4122	Standard Handle	Large	1 $\frac{1}{2}$ x 1 $\frac{3}{4}$ in	38 x 44 mm	9 $\frac{1}{2}$ in	241 mm
50-4123C	Ring-Grip Handle	Small	$\frac{3}{4}$ x 1 in	19 x 25 mm	9 $\frac{1}{2}$ in	241 mm
50-4124C	Ring-Grip Handle	Medium	1 x 1 $\frac{1}{4}$ in	32 mm	9 $\frac{1}{2}$ in	241 mm
50-4125C	Ring-Grip Handle	Large	1 $\frac{1}{4}$ x 1 $\frac{1}{2}$ in	38 mm	9 $\frac{1}{2}$ in	241 mm



23-4550

### Richardson-Eastman Retractor

Double-Ended

CODE	DESCRIPTION	BLADE (W X D)		LENGTH	
23-4550	Set of Two	$\frac{7}{8}$ x $\frac{5}{16}$ in	22 x 8 mm	10 in	254 mm
23-4551	Small Only	1 $\frac{1}{2}$ x 1 $\frac{5}{8}$ in	38 x 41 mm	10 in	254 mm
23-4552	Large Only	1 $\frac{3}{16}$ x 1 $\frac{3}{16}$ in	44 x 64 mm	10 $\frac{1}{2}$ in	267 mm
50-4135C	Set of Two (Small and Large)	1 $\frac{3}{4}$ x 2 $\frac{1}{2}$ in	44 x 64 mm	10 in	254 mm

### Roux Retractor

Double-Ended



22-1614

CODE	BLADE (W X D)		LENGTH	
22-1614	$\frac{7}{8}$ x 1 $\frac{1}{8}$ in	22 x 29 mm	5 $\frac{1}{2}$ in	140 mm
22-1615	1 x 1 $\frac{1}{2}$ in	25 x 38 mm	6 in	152 mm
22-1616	1 $\frac{1}{4}$ x 1 $\frac{3}{4}$ in	32 x 45 mm	6 $\frac{1}{2}$ in	166 mm

## General Purpose (Hand-Held)



23-1501

### Sauerbruch Retractor

CODE	DESCRIPTION	BLADE (W X D)	LENGTH
23-1501	#1	$\frac{3}{4} \times 1\frac{3}{4}$ in 19 x 44 mm	9 in 229 mm
23-1502	#2	$\frac{15}{16} \times 2\frac{1}{8}$ in 24 x 54 mm	9 in 229 mm
23-1503	#3	$\frac{13}{16} \times 2\frac{7}{8}$ in 21 x 73 mm	9 in 229 mm



### Schoenborn Retractor

CODE	BLADE (W X D)	LENGTH
20-4460	$\frac{1}{2} \times \frac{1}{4}$ in 13 x 6 mm	8 in 203 mm



50-4261

### Senn Retractor

Double-Ended

CODE	DESCRIPTION	PRONG (W)	BLADE (W X D)	LENGTH
20-0508	3 Prong, Sharp	$\frac{5}{16}$ in 8 mm	$\frac{1}{4} \times \frac{3}{4}$ in 6 x 19 mm	6 $\frac{1}{4}$ in 159 mm
50-4260	3 Prong, Sharp	$\frac{5}{16}$ in 8 mm	$\frac{1}{4} \times \frac{3}{4}$ in 6 x 19 mm	6 $\frac{7}{8}$ in 175 mm
20-0509	3 Prong, Blunt	$\frac{5}{16}$ in 8 mm	$\frac{1}{4} \times \frac{3}{4}$ in 6 x 19 mm	6 $\frac{1}{4}$ in 159 mm
50-4261	3 Prong, Blunt	$\frac{5}{16}$ in 8 mm	$\frac{1}{4} \times \frac{3}{4}$ in 6 x 19 mm	6 $\frac{7}{8}$ in 175 mm

## General Purpose (Hand-Held)



32-3661

### Sofield Hand-Held Retractor

Double Ended

CODE	DESCRIPTION	DIMENSIONS
32-3667	For use with 32-3660	5½ in 140 mm
32-3661	Sofield Retractor	63 x 13 mm and 38 x 13 mm
32-3662	Sofield Retractor	70 x 13 mm and 44 x 13 mm
32-3664	Sofield Retractor	89 x 16 mm and 57 x 16 mm
32-3665	Sofield Retractor	102 x 19 mm and 70 x 19 mm
32-3666	Sofield Retractor	114 x 19 mm and 76 x 19 mm



22-1553

### Sofield Retractor

Double Ended

CODE	DESCRIPTION	DIMENSIONS
22-1551	Sofield Retractor	63 x 13 mm and 38 x 13 mm
22-1552	Sofield Retractor	70 x 13 mm and 44 x 13 mm
22-1553	Sofield Retractor	83 x 16 mm and 51 x 16 mm
22-1554	Sofield Retractor	89 x 16 mm and 57 x 16 mm
22-1555	Sofield Retractor	102 x 19 mm and 70 x 19 mm
22-1556	Sofield Retractor	114 x 19 mm and 76 x 19 mm



### St. Marks Retractor

CODE	DESCRIPTION	DIMENSIONS
502-002	With Lip, 51–64 mm Taper	5 in 127 mm

## General Purpose (Hand-Held)



### St. Marks Pelvic Retractor

CODE	DESCRIPTION	HANDLE	BLADE	LENGTH
50-9023	With Lip		5 in 127 mm	13 in 330 mm
50-9028	With Lip	Angled 15°	11 in 279 mm	13 in 330 mm
50-9024	With Lip	Angled	5 in 127 mm	
50-9027	With Lip	Angled 15°	9 in 229 mm	11½ in 292 mm
50-9025	With Lip	Angled 15°	7 in 178 mm	13¾ in 350 mm
50-9020	Tapered, with Lip	Angled	7 in 178 mm	13¾ in 350 mm
50-9020FO	Tapered, with Lip; Fiber Optic Attachment	Angled	7 in 178 mm	13¾ in 350 mm
50-9025FO	With Lip, Fiber Optic Attachment	Angled 15°	7 in 178 mm	13⅞ in 340 mm
50-9027FO	With Lip, Fiber Optic Attachment	Angled 15°	9 in 229 mm	13⅞ in 340 mm
50-9026	Without Lip		7 in 178 mm	11 in 279 mm



### St. Marks Pelvic Retractor

With Ratchet and Swivel Blades

CODE	LENGTH
50-9021	11 in 279 mm



32-3628

### Turner-Doyen Retractor Blade

CODE	WIDTH	DEPTH	TOTAL LENGTH
32-3628	2⅜ in 60 mm	5½ in 140 mm	11½ in 292 mm

## General Purpose (Hand-Held)



### University Of Minnesota Retractor & Tongue Depressor

CODE	DESCRIPTION	DIMENSIONS	
72-0210	Cheek Retractor	5½ in	140 mm

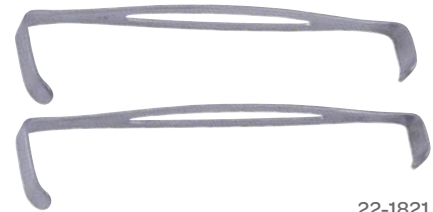

### Us Army Retractor

22-1821

CODE	DESCRIPTION	DIMENSIONS	
22-1821	Double-Ended, Set of 2	8¼ in	209 mm
50-4071	Double-Ended, Set of 2	8¼ in	209 mm



50-4226CO

### Volkman Retractor

CODE	DESCRIPTION	BLADE (W X D)	LENGTH
22-3402	2 Prong, Sharp	Standard Pattern	8¾ in 222 mm
22-3403	3 Prong, Sharp	Standard Pattern	8¾ in 222 mm
22-3404	4 Prong, Sharp	Standard Pattern	8¾ in 222 mm
22-3406	6 Prong, Sharp	Standard Pattern	8¾ in 222 mm
22-3502	2 Prong, Blunt	Standard Pattern	8¾ in 222 mm
22-3503	3 Prong, Blunt	Standard Pattern	8¾ in 222 mm
22-3504	4 Prong, Blunt	Standard Pattern	8¾ in 222 mm
22-3506	6 Prong, Blunt	Standard Pattern	8¾ in 222 mm
50-4220CO	2 Prong, Sharp	7/16 x 11/16 in 11 x 17 mm	8¾ in 222 mm
50-4221CO	3 Prong, Sharp	11/16 x 11/16 in 11 x 17 mm	8¾ in 222 mm
50-4222CO	4 Prong, Sharp	15/16 x 11/16 in 24 x 17 mm	8¾ in 222 mm
50-4223CO	6 Prong, Sharp	1½ x 11/16 in 17 x 38 mm	8¾ in 222 mm
50-4225CO	2 Prong, Blunt	7/16 x 11/16 in 11 x 17 mm	8¾ in 222 mm
50-4226CO	3 Prong, Blunt	11/16 x 11/16 in 17 x 17 mm	8¾ in 222 mm
50-4227CO	4 Prong, Blunt	15/16 x 11/16 in 24 x 17 mm	8¾ in 222 mm
50-4228CO	6 Prong, Blunt	1½ x 11/16 in 38 x 17 mm	8¾ in 222 mm



## General Purpose (Lighted)



67-2490

### Fiber Optic Retractor

CODE	DESCRIPTION	DIMENSIONS
67-2490	Judy's Skini Mini	$1\frac{5}{32}$ x $3\frac{3}{8}$ in 12 x 85 mm
67-2492	Judy's Skini Mini	$1\frac{5}{32}$ x $4\frac{3}{4}$ in 12 x 120 mm

## General Purpose (Self-Retaining)



32-3654

### Henly Retractor Blade

CODE	DESCRIPTION	DIMENSIONS
32-3652	3 Pair Side Blades, 4 Center Blades	
32-3654	Center	$\frac{5}{8}$ x $\frac{3}{4}$ in 16 x 19 mm
32-3655	Center	$\frac{5}{8}$ x 1 in 16 x 25 mm
32-3656	Center	$\frac{5}{8}$ x $1\frac{1}{4}$ in 16 x 32 mm
32-3657	Left/Right, Pair	1 x 1 in 25 x 25 mm
32-3658	Left/Right, Pair	1 x 2 in 25 x 51 mm
32-3659	Left/Right, Pair	$\frac{7}{8}$ x 3 in 22 x 76 mm
32-3653	Body Only: $3\frac{3}{16}$ in, Max Opening 80 mm	

### Gelpi Perineal Retractor



CODE	DESCRIPTION	TOTAL OPENING	LENGTH
50-1210	Self-Retaining	$3\frac{3}{4}$ in 95 mm	$7\frac{1}{4}$ in 184 mm

## General Purpose (Self-Retaining)



24-4013

### Gelpi Retractor

CODE	DESCRIPTION	LENGTH	WIDTH
24-4013		3½ in 89 mm	
24-4015		4½ in 114 mm	
24-4018		6¾ in 121 mm	
24-4017	Tips Bent 90°	6¾ in	171 mm
24-4057	With Ball Stops	7½ in	191 mm



50-8160

### Darling Popliteal Retractor

CODE	DESCRIPTION	DIMENSIONS
55-8998	Left	6¼ in 159 mm
55-8997	Right	6¼ in 159 mm
50-8160	Self-Retaining, Left	6¼ in 159 mm
50-8161	Self-Retaining, Right	6¼ in 159 mm



24-1007

### Alm Self-Retaining Retractor

CODE	DESCRIPTION	LENGTH
24-1007	4 x 4 Prongs, Sharp	2¾ in 70 mm
24-1010	4 x 4 Prongs, Sharp	4 in 102 mm
24-1008	4 x 4 Prongs, Blunt	2¾ in 70 mm
24-1011	4 x 4 Prongs, Blunt	4 in 102 mm

## General Purpose (Self-Retaining)



80-1813

### Alm Retractor-Microvasc Modified Alm Retractor

Black Anodized

CODE	DESCRIPTION	LENGTH
80-1812	4 x 4 Prong	8 ¼ in 210 mm
80-1813	12 x 12 Prong	8 ¼ in 210 mm



### Alms Wound Retractor

CODE	DESCRIPTION	PRONG DEPTH	TOTAL OPENING	LENGTH
50-4265	Semi-Sharp Prongs	⅛ in 3 mm	2 in 51 mm	3 in 76 mm



### Bellucci Retractor

CODE	DESCRIPTION	LENGTH
24-2625	Arms Angled Downward, 3 x 3 Prong, Sharp	5 ⅛ in 130 mm



61-0605

### Bellucci-Wullstein Retractor

CODE	DESCRIPTION	LENGTH
61-0606	Solid Blade on Left, 2 Prong, Blunt	5 in 140 mm
61-0605	Solid Blade on Right, 2 Prong, Blunt	5 in 140 mm

## General Purpose (Self-Retaining)

### Farr Spring Retractor

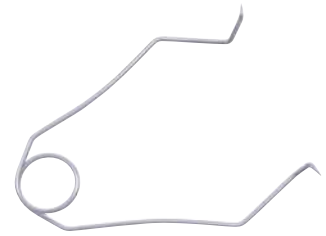

24-0307

CODE	PRONG	LENGTH
24-0307	1 in 25 mm	5½ in 140 mm
24-0306	1 in 25 mm	9 in 229 mm

### Heiss Retractor

4 x 4 Prongs, Cross-Action



24-0911

CODE	DESCRIPTION	LENGTH	CODE	DESCRIPTION	LENGTH
24-0909	Sharp	4 in 102 mm	24-0910	Blunt	4 in 102 mm
24-0911	Sharp	4 in 102 mm	24-0912	Blunt	4 in 102 mm

### Hinterman Retractor



Tip

CODE	DESCRIPTION	LENGTH
78-5599	With K-Wire Guide	7 in 177 mm

### Horizontal Retractor



CODE	DESCRIPTION	LENGTH
24-3500	4 x 2 Sharp Prong	12¼ in 310 mm

## General Purpose (Self-Retaining)



### Kolbel Retractor

CODE	DESCRIPTION	LENGTH
24-4175	2 x 2 in, Prongs, Angled	7 in 177 mm



24-4167

### Kolbel Retractor

CODE	DESCRIPTION	DIMENSIONS (W X D)	
24-4166	Frame Only for Snap Closure Blades		
24-4167	Kolbel Snap on Retractor Blades	36 x 36 in	1 <sup>7</sup> / <sub>16</sub> in, 1 <sup>7</sup> / <sub>16</sub> in
24-4168	Kolbel Snap on Retractor Blades	36 x 53 in	1 <sup>7</sup> / <sub>16</sub> in, 2 <sup>1</sup> / <sub>16</sub> in
24-4169	Kolbel Snap on Retractor Blades	36 x 68 in	1 <sup>7</sup> / <sub>16</sub> in, 2 <sup>11</sup> / <sub>16</sub> in
24-4170	Kolbel Snap on Retractor Blades	36 x 85 in	1 <sup>7</sup> / <sub>16</sub> in, 3 <sup>3</sup> / <sub>8</sub> in
24-4172	Kolbel Snap on Retractor Blades	20 x 36 in	1 <sup>3</sup> / <sub>16</sub> in, 1 <sup>7</sup> / <sub>16</sub> in
24-4173	Kolbel Snap on Retractor Blades	20 x 53 in	1 <sup>3</sup> / <sub>16</sub> in, 2 <sup>1</sup> / <sub>16</sub> in
24-4176	Kolbel Snap on Retractor Blades	20 x 68 in	1 <sup>3</sup> / <sub>16</sub> in, 2 <sup>11</sup> / <sub>16</sub> in
24-4178	Kolbel Snap on Retractor Blades	20 x 85 in	1 <sup>3</sup> / <sub>16</sub> in, 3 <sup>3</sup> / <sub>8</sub> in

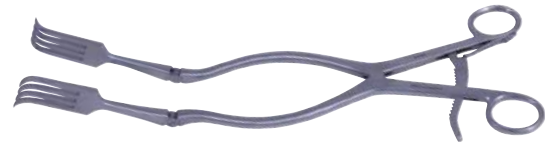

### Oberhill Retractor

CODE	DESCRIPTION	LENGTH
24-3449	4 Prong Hinged Blades	13 in 330 mm

### Perkins Retractor

Solid Blades with Spikes



66-6651

CODE	DESCRIPTION	SPREAD
66-6650	3 Sharp Prong on Left	5 in 127 mm
66-6651	3 Sharp Prong on Right	5 in 127 mm

## General Purpose (Self-Retaining)

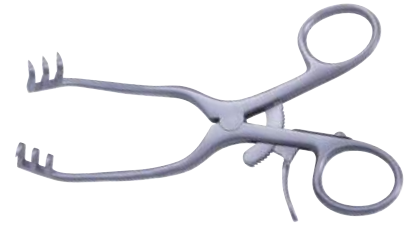

### Schuknecht Retractor

CODE	DESCRIPTION	DIMENSIONS	
24-2620	Double Curved Arms, 3 x 3 Prong, Sharp	5 1/8 in	130 mm



### Seeburger Retractor

CODE	DIMENSIONS
22-0101	5 1/2 in 140 mm

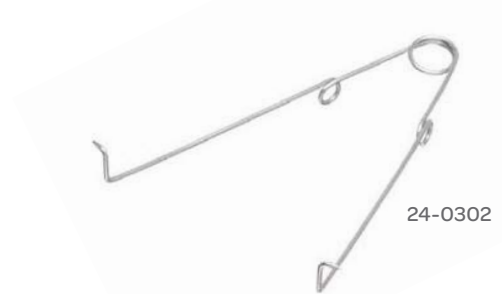

### Spring Retractor

CODE	DESCRIPTION	LENGTH	
24-0300	1 x 1 Prong, Sharp	2 1/2 in	64 mm
24-0301	1 x 1 Prong, Sharp	3 1/2 in	89 mm
24-0352	1 x 1 Prong, Sharp	4 1/8 in	105 mm
24-0302	1 x 1 Prong, Sharp	4 1/2 in	114 mm
24-0327	1 x 1 Prong, Sharp		
24-0303	3 x 3 Prongs, Blunt	3 1/2 in	89 mm
24-0304	3 x 3 Prongs, Blunt	4 1/2 in	114 mm
50-4350	Prong 3/8 in, (10 mm)	3 1/8 in	79 mm

### Tissue Retractors

Blunt



CODE	DESCRIPTION	PRONG (W X D)		TOTAL OPENING		LENGTH	
50-1223	3 x 3 Prongs	1/2 in	5/8 in	2 1/2 in	64 mm	5 1/4 in	133 mm
50-1224	1 x 1 Prong	1/2 in	13 mm	2 1/2 in	64 mm	5 1/4 in	133 mm

## General Purpose (Hand-Held)



### Volkman Retractor

CODE	DESCRIPTION	DIMENSIONS	
22-3604	4 Prong Sharp, USA Pattern	8 <sup>3</sup> / <sub>4</sub> in	222 mm



### Volkman Retractor

50-4226CO

CODE	DESCRIPTION	BLADE (W X D)		LENGTH	
22-3402	2 Prong, Sharp	Standard Pattern		8 <sup>3</sup> / <sub>4</sub> in	222 mm
22-3403	3 Prong, Sharp	Standard Pattern		8 <sup>3</sup> / <sub>4</sub> in	222 mm
22-3404	4 Prong, Sharp	Standard Pattern		8 <sup>3</sup> / <sub>4</sub> in	222 mm
22-3406	6 Prong, Sharp	Standard Pattern		8 <sup>3</sup> / <sub>4</sub> in	222 mm
22-3502	2 Prong, Blunt	Standard Pattern		8 <sup>3</sup> / <sub>4</sub> in	222 mm
22-3503	3 Prong, Blunt	Standard Pattern		8 <sup>3</sup> / <sub>4</sub> in	222 mm
22-3504	4 Prong, Blunt	Standard Pattern		8 <sup>3</sup> / <sub>4</sub> in	222 mm
22-3506	6 Prong, Blunt	Standard Pattern		8 <sup>3</sup> / <sub>4</sub> in	222 mm
50-4220CO	2 Prong, Sharp	<sup>7</sup> / <sub>16</sub> x <sup>11</sup> / <sub>16</sub> in	11 x 17 mm	8 <sup>3</sup> / <sub>4</sub> in	222 mm
50-4221CO	3 Prong, Sharp	<sup>11</sup> / <sub>16</sub> x <sup>11</sup> / <sub>16</sub> in	11 x 17 mm	8 <sup>3</sup> / <sub>4</sub> in	222 mm
504222CO	4 Prong, Sharp	<sup>15</sup> / <sub>16</sub> x <sup>11</sup> / <sub>16</sub> in	24 x 17 mm	8 <sup>3</sup> / <sub>4</sub> in	222 mm
50-4223CO	6 Prong, Sharp	1 <sup>1</sup> / <sub>2</sub> x <sup>11</sup> / <sub>16</sub> in	17 x 38 mm	8 <sup>3</sup> / <sub>4</sub> in	222 mm
50-4225CO	2 Prong, Blunt	<sup>7</sup> / <sub>16</sub> x <sup>11</sup> / <sub>16</sub> in	11 x 17 mm	8 <sup>3</sup> / <sub>4</sub> in	222 mm
50-4226CO	3 Prong, Blunt	<sup>11</sup> / <sub>16</sub> x <sup>11</sup> / <sub>16</sub> in	17 x 17 mm	8 <sup>3</sup> / <sub>4</sub> in	222 mm
504227CO	4 Prong, Blunt	<sup>15</sup> / <sub>16</sub> x <sup>11</sup> / <sub>16</sub> in	24 x 17 mm	8 <sup>3</sup> / <sub>4</sub> in	222 mm
50-4228CO	6 Prong, Blunt	1 <sup>1</sup> / <sub>2</sub> x <sup>11</sup> / <sub>16</sub> in	38 x 17 mm	8 <sup>3</sup> / <sub>4</sub> in	222 mm

## General Purpose (Self-Retaining)

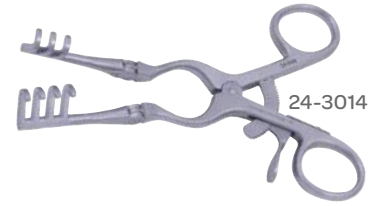

### Weitlaner-Beckman Retractor

CODE	DESCRIPTION	LENGTH
24-3013	3 x 4 Prong, Sharp, Hinged Arms	5½ in 140 mm
24-3016	3 x 4 Prong, Sharp, Hinged Arms	6½ in 165 mm
24-3020	3 x 4 Prong, Sharp, Hinged Arms	8½ in 215 mm
24-3023	3 x 4 Prong, Sharp, Hinged Arms	9½ in 241 mm
24-3014	3 x 4 Prong, Blunt, Hinged Arms	5½ in 140 mm
24-3017	3 x 4 Prong, Blunt, Hinged Arms	6½ in 165 mm
24-3024	3 x 4 Prong, Blunt, Hinged Arms	8 in 215 mm
24-3021	3 x 4 Prong, Blunt, Hinged Arms	9½ in 241 mm



### Weitlaner Retractor

CODE	DESCRIPTION	LENGTH
24-2210	2 x 3 Prongs, Sharp	4½ in 114 mm
24-2213	3 x 4 Prongs, Sharp	5½ in 140 mm
24-2216	3 x 4 Prongs, Sharp	6½ in 165 mm
24-2220	3 x 4 Prongs, Sharp	8 in 203 mm
24-2224	3 x 4 Prongs, Sharp	9 in 229 mm
24-2211	2 x 3 Prongs, Blunt	4½ in 114 mm
24-2214	3 x 4 Prongs, Blunt	5½ in 140 mm
24-2217	3 x 4 Prongs, Blunt	6½ in 165 mm
24-2221	3 x 4 Prongs, Blunt	8 in 203 mm
24-2225	3 x 4 Prongs, Blunt	9 in 229 mm



### Weitlaner Pediatric Retractor

CODE	DESCRIPTION	DIMENSIONS
61-0610	3 x 3 Prong, Blunt	4½ in 115 mm



## General Purpose (Self-Retaining)



### Weitlaner Retractor

CODE	DESCRIPTION	TOTAL OPENING	LENGTH
50-5647	2 x 3 Prong, Blunt	2¼ in 57 mm	4½ in 114 mm



50-1194

### Weitlaner Retractor

Self-Retaining Prongs

CODE	DESCRIPTION	TOTAL OPENING	LENGTH
50-5646	2 X 3 Prongs, Sharp	2¼ in 57 mm	4½ in 114 mm
50-1194	3 x 4 Prongs, Sharp	2¼ in 57 mm	5½ in 140 mm
50-1196	3 x 4 Prongs, Sharp	4 in 102 mm	6½ in 165 mm
50-1198	3 x 4 Prongs, Sharp	5 in 127 mm	7½ in 191 mm
50-1200	3 X 4 Prongs, Sharp	5¾ in 146 mm	9 in 229 mm
50-5647	2 X 3 Prongs, Blunt	2¼ in 57 mm	4½ in 114 mm
50-1195	3 x 4 Prongs, Blunt	2¼ in 57 mm	5½ in 140 mm
50-1197	3 x 4 Prongs, Blunt	4 in 102 mm	6½ in 165 mm
50-1199	3 x 4 Prongs, Blunt	5 in 127 mm	7½ in 191 mm
50-1201	3 X 4 Prongs, Blunt	5¾ in 146 mm	9 in 229mm

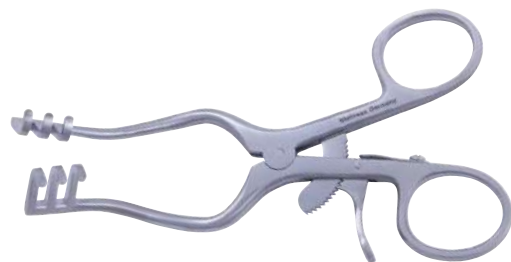

24-2614

### Weitlaner-Wullstein Retractor

Arms Angled Downward

CODE	DESCRIPTION	DIMENSIONS
24-2613	3 x 3 Prong, Sharp	5⅛ in 130 mm
24-2614	3 x 3 Prong, Blunt	5⅛ in 130 mm

## General Purpose (Self-Retaining)



57-2952

### Williams Micro Dissectomy Retractor

CODE	DESCRIPTION	DIMENSIONS	TOTAL LENGTH
57-2951	Left Hook	50 x 10 mm	6 in 152 mm
57-2952	Left Hook	50 x 20 mm	6 in 152 mm
57-2961	Left Hook	60 x 10 mm	6 in 152 mm
57-2971	Left Hook	70 x 10 mm	6 in 152 mm
57-2972	Left Hook	70 x 20 mm	6 in 152 mm
57-2851	Right Hook	50 x 10 mm	6 in 152 mm
57-2852	Right Hook	50 x 20 mm	6 in 152 mm
57-2862	Right Hook	60 x 20 mm	6 in 152 mm
57-2871	Right Hook	70 x 10 mm	6 in 152 mm
57-2872	Right Hook	70 x 20 mm	6 in 152 mm

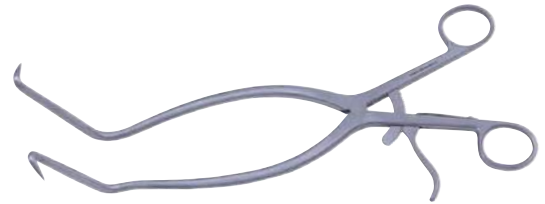

### Wiltse-Gelpi Retractor

Deep Blades

CODE	DESCRIPTION	LENGTH
24-4760	1 x 1 Prongs, Sharp	11 in 279 mm

## Hysterectomy



50-5566

### Heaney Hysterectomy Retractor

CODE	DIMENSIONS (W X D)	DIMENSIONS
50-5566	1 1/8 x 2 7/8 in 29 x 73 mm	6 1/2 in 165 mm
50-5567	1 1/8 x 3 1/4 in 29 x 82 mm	6 1/2 in 165 mm
52-2751	1 x 1 3/4 in 25 x 45 mm	6 3/4 in 171 mm
52-2752	1 1/8 x 2 7/8 in 29 x 73 mm	6 3/4 in 171 mm
52-2753	1 1/8 x 3 1/4 in 29 x 85 mm	6 3/4 in 171 mm

## Hysterectomy

### Heaney-Simon Hysterectomy Retractor

CODE	DIMENSIONS (W X L)	
50-5570	1 x 4 ½ in	25 x 114 mm
52-2727	1 x 4 ½ in	25 x 114 mm

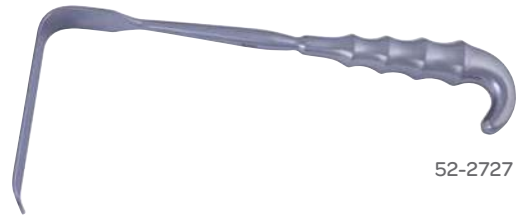

52-2727

## Laparoscopic

### Fan Retractor

CODE	DESCRIPTION	LENGTH
24-1800	Pressure Lock Handle, 60° Opening 10 mm, 60 mm	9 ½ in 241 mm
32-1800	Pressure Lock Handle, 60° Opening 10 mm, 60 mm	12 ¾ 320 mm
38-1800	Pressure Lock Handle, 60° Opening 10 mm, 60 mm	15 in 381 mm
45-1800	Pressure Lock Handle, 60° Opening 10 mm, 60 mm	17 ¾ 450 mm



24-1800

### Fan Retractor

CODE	DESCRIPTION
90-9800	Curved, 5 mm



### Hasson "S" Retractor

Set of Two

CODE	WIDTH		LENGTH
90-6003	¼ in	6.3 mm	6 in 152 mm
90-6002	⅜ in	10 mm	6 ¾ in 171 mm
90-6004	½ in	13 mm	6 in 152 mm
90-6008	½ in	13 mm	7 in 177 mm
90-6005	⅜ in	10 mm	7 ⅛ in 180 mm
90-6006	⅝ in	15 mm	7 ⅞ in 180 mm
90-6007	¾ in	19 mm	7 ⅞ in 180 mm

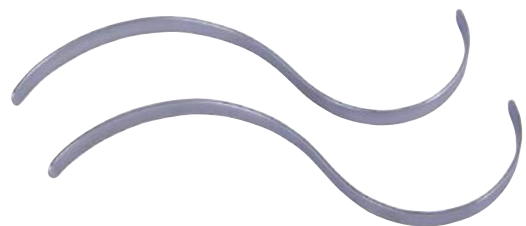

90-6002

## Laparoscopic (Bookwalter®)

### Bookwalter® Telescopic Laparoscopic Holder

CODE	DESCRIPTION
50-4685	Telescopic with Instrument holder for instruments, trocars and laparoscopic retractors 5 mm - 17 mm.



### Bookwalter® Universal Flex Arm System

CODE	DESCRIPTION
50-4805	Bookwalter® Universal Flex Arm System Includes Arm and One Each of the Adapters Below.
50-4806	Ring Adapter For Bookwalter® Flex Arm
50-4807	Lap Instrument Adapter (Spring) For Bookwalter® Flex Arm
50-4808	Camera Lens Adapter For Bookwalter® Flex Arm
50-4809	Camera Housing Adapter For Bookwalter® Flex Arm

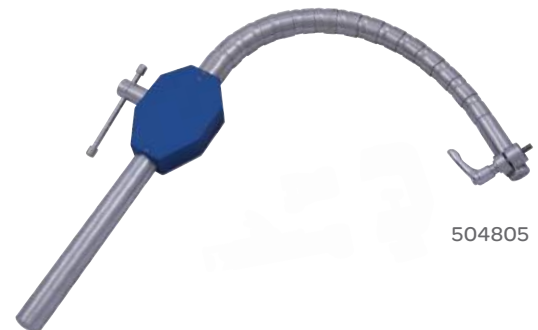

### Laparoscopic Support Set

CODE	DESCRIPTION	QTY
50-5730	Laparoscopic Support Set Includes the Following:	
50-4683	Bookwalter® Table Post, 8 in	1
50-4554	Bookwalter® Post Coupling	1
50-4805	Bookwalter® Universal Flex Arm, Includes 4 Adapters Listed Below	1
50-4806	Bookwalter® Flex Arm Ring Adapter	1
50-4807	Bookwalter® Flex Arm Laparoscopic Instrument Adapter	1
50-4808	Bookwalter® Flex Arm Camera Lens Adapter	1
50-4809	Bookwalter® Flex Arm Camera Housing Adapter	1
68-1593	Fan Retractor, 5mm, Articulating, 3 Fingers	1
68-1594	Fan Retractor, 10mm, Articulating, 5 Fingers	1

## Lung



50-8153

### Allison Lung Retractor

CODE	DESCRIPTION	LENGTH	
50-8152	Adult, Small	10½ in	267 mm
50-8153	Adult, Large	12½ in	318 mm



59-0100

### Ultra™ Side Loading Retractor

CODE	DESCRIPTION	LENGTH	
59-0101	Longitudinal, Table Mounted, with Double Hinge	14 x 15 in	356 x 381 mm
59-0100	Transverse 4¾ in (120 mm) Rack, Table Mounted, with Double Hinge	2¾ x 2 in	70 x 51 mm



### Bookwalter® I.M.A. Crossbar

CODE	DESCRIPTION	LENGTH	
50-4601	Table Mounted, Small	12 in	305 mm

## Mastectomy

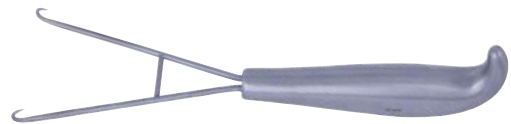

### Berens Mastectomy Retractor

CODE	DESCRIPTION	LENGTH	
22-3600	Square	7⅞ in	200 mm

## Mouth Gags



72-0515

### Sluder Jansen/Schink Mouth Gag

CODE	DESCRIPTION	LENGTH
72-0515	Adult	4 ¼ in 108 mm

## Neuro (Flap)



22-2003

### Freeman Flap Retractor

CODE	BLADE WIDTH	LENGTH
22-2002	12 mm	8 in 220 mm
22-2003	25 mm	8 in 220 mm



22-2006

### Maxwell Flap Retractor

CODE	WIDTH	LENGTH
22-2007	22 mm	4 in 101 mm
22-2006	38 mm	4 in 101 mm

## Neuro (Hand-Held)



22-0057

### Davis Brain Spatula

Malleable

CODE	DESCRIPTION	LENGTH
22-0057	$\frac{3}{8}$ in 10 mm	7 in 177 mm
22-0070	$\frac{7}{8}$ in 22 mm	8 $\frac{3}{4}$ in 222 mm

## Neuro (Lachrymal Sac)



### Agricola Lachrymal Sac Retractor

CODE	DESCRIPTION	LENGTH
60-1416	3 x 3 Prong, Sharp	1 $\frac{1}{2}$ in 40 mm

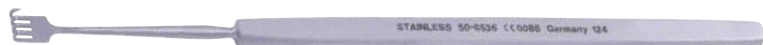

### Rollet Lachrymal Sac Retractor

CODE	DESCRIPTION	LENGTH
50-6536	4 Prongs, Sharp	5 $\frac{1}{4}$ in 133 mm

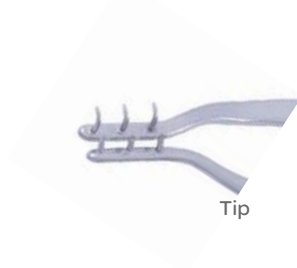

Tip



60-1413

### Stevenson Lachrymal Sac Retractor

CODE	DESCRIPTION
60-1413	Curved Teeth, 20 mm Spread

## Neuro (Posterior Fossa)

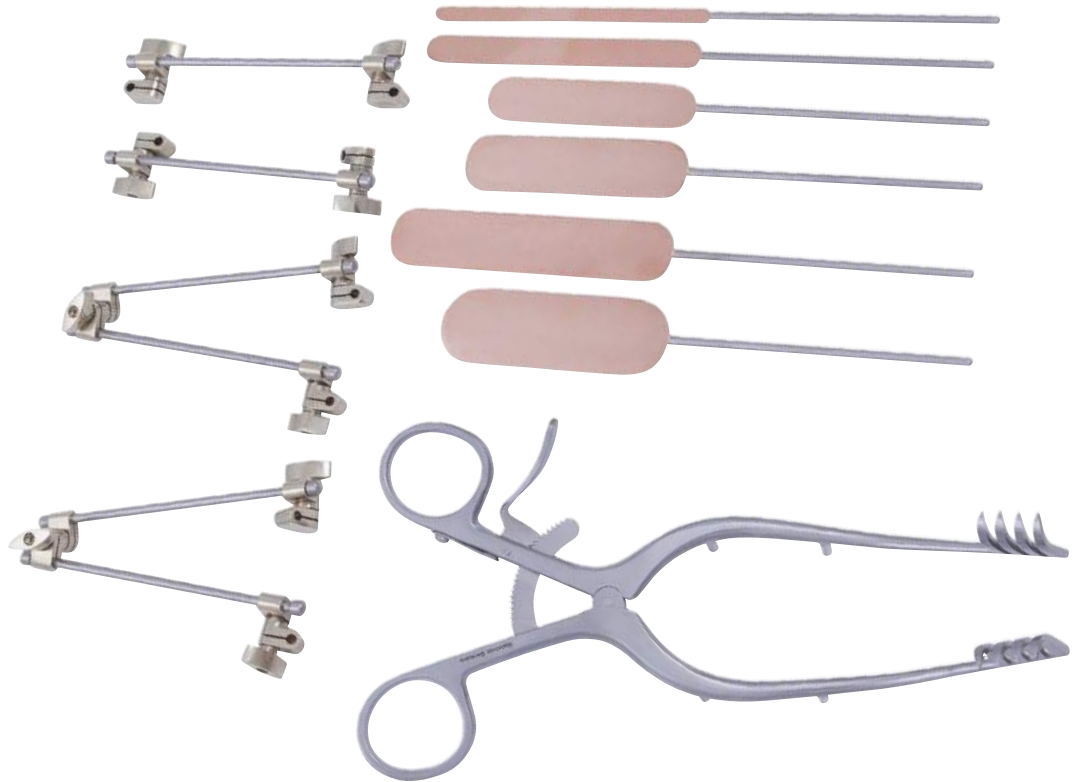

### Jannetta Posterior Fossa Retractor

57-9000

CODE	DESCRIPTION	DETAIL	DIMENSIONS	
57-9000	Complete Set Including:			
57-9024	Double Round Bar	3 Swivels	4 in	260 mm
57-9028	Malleable Retractor Blade	15 x 70 mm	6½ in	165 mm
57-9030	Malleable Retractor Blade	20 x 75 mm	6¾ in	171 mm
57-9032	Malleable Retractor Blade	25 x 75 mm	6¾ in	171 mm
57-9034	Malleable Retractor Blade	10 x 95 mm	7½ in	190 mm
57-9036	Malleable Retractor Blade	20 x 95 mm	7½ in	190 mm
57-9038	Malleable Retractor Blade	5 x 95 mm	7½ in	190 mm
57-9022	Retractor Body	with 4 Posts	4 in	100 mm
57-9026	Round Bar	with 2 Swivels	4 in	100 mm



## Neuro (Self-Retaining)



### Malis® Brain Retractor Kit

Black Anodized, Attaches to the Malis® Cerebellar Retractor (50-1465)

CODE	DESCRIPTION	QTY	LENGTH	WIDTH
50-1460	Includes One Each of the Five Blades and Three Extensions Listed Below:			
	Blade	1	3 in 76 mm	$\frac{3}{8}$ in 10 mm
	Blade	1	3 in 76 mm	$\frac{9}{16}$ in 14 mm
	Blade	1	3 in 76 mm	$\frac{5}{8}$ in 16 mm
	Blade	1	3 in 76 mm	$\frac{3}{4}$ in 19 mm
	Blade	1	3 in 76 mm	$\frac{3}{8}$ in 10 mm
	Retractor Extension	1	2 in 51 mm	
	Retractor Extension	1	3 in 76 mm	
	Retractor Extension	1	4 in 102 mm	
50-1454	Double Connector	2		

## Neuro (Greenberg®)



### Greenberg® Maxi-Vise Adapter

Double the holding diameter of arms from 4mm to 8mm.  
Useful for holding suction devices and other various micro-surgical instruments.

CODE	DESCRIPTION
50-1515	Attaches to the Greenberg® Flexible Arms (50-1509 and 50-1511)



50-1525

### Greenberg® Instrument Holder

CODE	DESCRIPTION
50-1523	Small, Holds Shafts Up to $\frac{5}{16}$ in (8mm) In Diameter and Flat Instruments
50-1524	Large, Holds Shafts Up to 1 in (25mm) In Diameter and Flat Instruments
50-1525	Extra Large, Holds Shafts Up to 2 in (51mm) In Diameter and Flat Instruments

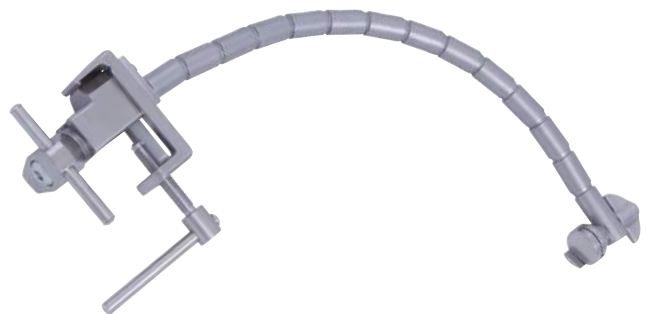

### Greenberg® Long Arm

CODE	DESCRIPTION
50-1509	Attaches to Primary or Secondary Bar

## Neuro (Greenberg®)



### Greenberg® Micro Instrument Holder Collateral Retractor

CODE	DESCRIPTION
50-1529	Flexbar Arm Used to Hold Microinstruments, Holds Up to 1/8 in (3 mm) Diameter



### Greenberg® Short

CODE	DESCRIPTION	LENGTH
50-1511	Attaches to Primary Bar or Secondary Arm	6 1/2 in    165 mm



### Greenberg®

CODE	DESCRIPTION	LENGTH
50-1516	Attaches to Primary Bar or Secondary Arm	12 in    305 mm

## Neuro (Greenberg®)



### Greenberg® Primary Bar

CODE	DESCRIPTION	LENGTH	
50-1507	Attaches to Skull Clamp	6 in	152 mm



### Greenberg® Secondary Bar

CODE	DESCRIPTION	LENGTH	
50-1508	Attaches to Primary Bar	12 in	305 mm



### Greenberg® Short Coupler

CODE	DESCRIPTION	LENGTH	
50-1522	Can Be Used as Mount for the Greenberg® Handrest	5½ in	140 mm

## Neuro (Greenberg®)



50-1530

### Greenberg® Retractor Blade

Tapered

CODE	TAPERED BLADE WIDTH	BLADE LENGTH		
50-1534	$\frac{1}{16} \times \frac{1}{4}$ in	1.6 x 19 mm	9 in	229 mm
50-1533	$\frac{3}{32} \times \frac{3}{8}$ in	2 x 10 mm	9 in	229 mm
50-1532	$\frac{1}{8} \times \frac{1}{2}$ in	3 x 13 mm	9 in	229 mm
50-1531	$\frac{5}{32} \times \frac{5}{8}$ in	4 x 16 mm	9 in	229 mm
50-1530	$\frac{1}{4} \times \frac{3}{4}$ in	6 x 19 mm	9 in	229 mm



### Greenberg® Sterilizing Case

Includes Four Compartments for Various Components

CODE	DESCRIPTION	WIDTH		DEPTH		LENGTH	QTY
50-1514	Universal Retractor Case	10 in	254 mm	2 $\frac{1}{8}$ in	60 mm	17 in (432 mm)	1
Compartment Sizes							
	Compartment # 1	7 $\frac{3}{4}$ in	197 mm	10 $\frac{3}{4}$ in	264 mm		
	Compartment # 2	2 $\frac{1}{8}$ in	54 mm	17 in	432 mm		
	Compartment # 3	4 $\frac{5}{8}$ in	117 mm	6 $\frac{3}{4}$ in	171 mm		
	Compartment # 4	3 $\frac{1}{8}$ in	79 mm	6 $\frac{3}{4}$ in	171 mm		

## Neuro (Greenberg®)



### Greenberg® Hand Rest

CODE	DESCRIPTION	LENGTH	
50-1512	Attaches to Short Coupler (50-1509) or Secondary Bar (50-1508 or 50-1516)	10 in	254 mm



### Greenberg® Universal & Handrest Kit

CODE	DESCRIPTION	LENGTH	
50-1500	Universal and Handrest Kit	3½ in	89 mm



### Greenberg® Pattie Tray

CODE	DESCRIPTION	LENGTH	
50-1513	Attaches to Long (50-1509) or Short Arm (50-1511)	6¼ in	171 mm

## Neuro



### Ultra Greenberg® Style Cranial Pattie Tray

CODE	DESCRIPTION	LENGTH
59-7905	Titanium	6¼in 171 mm

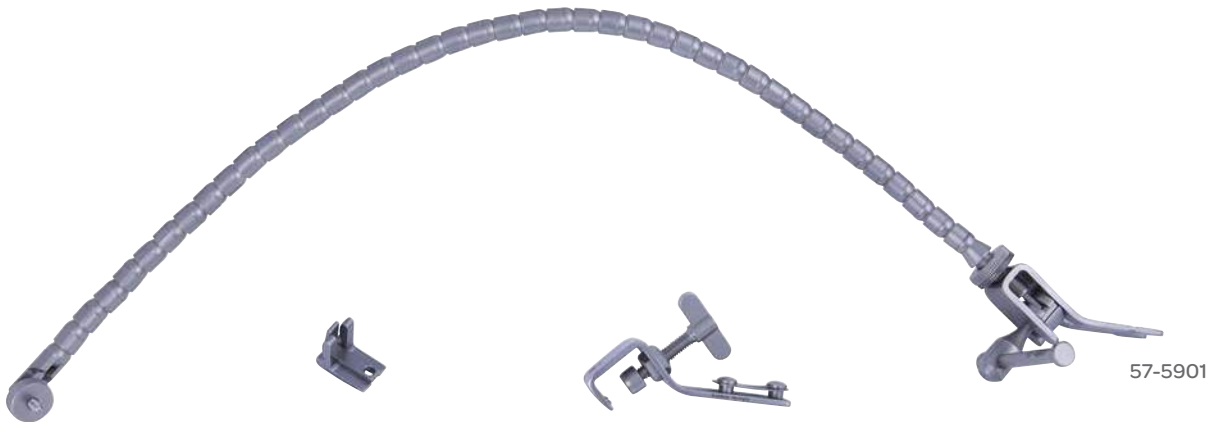

### Leyla Brain Retractor

CODE	DESCRIPTION
57-5910	Flexible Tension Arm
57-5941	Rigid Holding Arm
57-5901	Self-Retaining, One Armed
57-5902	Self-Retaining, Two Armed
57-5930	Spatula Support
57-5921	Fixation Base
57-5922	Fixation Base
57-5943	Ball Joint Clamp
57-5942	Coupling Head to Hold Flexible Arms

Neuro



Malis® Double Connector

CODE	DESCRIPTION
50-1454	For Use with 50-1460

RETRACTORS

Ophthalmology (Hand-Held)

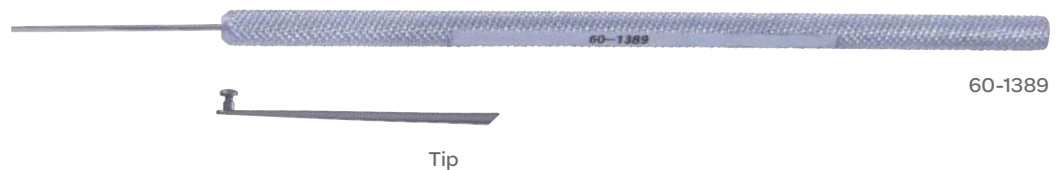

Graether Retractor

Collar Button on Handle

CODE	DESCRIPTION	LENGTH
60-1389	Straight	4 ¾ in 120 mm
60-1390	Angled	4 ¾ in 120 mm



## Ophthalmology (Hand-Held)



60-1937

### Guyton-Park Speculum

Horizontal Suture Posts

CODE	DESCRIPTION	LENGTH	
60-1937	14 mm Wide, Fenestrated Blades	3 <sup>3</sup> / <sub>8</sub> in	86 mm
60-1938	14 mm Wide, Solid Blades	3 <sup>3</sup> / <sub>8</sub> in	86 mm

## Ophthalmology (Lens Capsule)



Tip

### Mackool Lens Capsule Retractor

CODE	DESCRIPTION	LENGTH	
60-1943	1 mm Hook Suspended 0.5 mm From End of Tip, 45° Angled Shaft	4 <sup>3</sup> / <sub>4</sub> in	120 mm

## Ophthalmology (Lid)



60-1404

### Desmarres Lid Retractor

CODE	SIZE	WIDTH	LENGTH	
60-1404	Size 0	11 mm	5 <sup>1</sup> / <sub>2</sub> in	140 mm
60-1405	Size 1	13 mm	5 <sup>1</sup> / <sub>2</sub> in	140 mm
60-1406	Size 2	15 mm	5 <sup>1</sup> / <sub>2</sub> in	140 mm
60-1407	Size 3	16 mm	5 <sup>1</sup> / <sub>2</sub> in	140 mm
60-1403	Size 4	18 mm	5 <sup>1</sup> / <sub>2</sub> in	140 mm

## Ophthalmology (Lid)

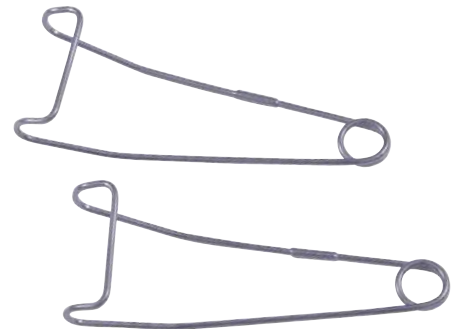

### Jaffe Lid Retractor

CODE	WIDTH
60-1408	9 mm Wide



### Hardy™ Lip Retractor

CODE
80-1337

## Ophthalmology (Orbital)



### Schepens Orbital Retractor

CODE	DESCRIPTION	LENGTH
60-5008	Smooth 14 x 57 mm, Blade with Notched End, 4.5 mm Wide Notch	6 in 152 mm

## Ophthalmology (Orbital)



63-4003

### Sewall Orbital Retractor

CODE	BLADE	LENGTH
63-4003	7x52 mm	6 <sup>3</sup> / <sub>4</sub> in 170 mm
63-4004	9x51 mm	6 <sup>3</sup> / <sub>4</sub> in 170 mm
63-4005	11x50 mm	6 <sup>3</sup> / <sub>4</sub> in 170 mm

## Ophthalmology (Self-Retaining)



60-2003

### Lieberman Open Wire Speculum

CODE	DESCRIPTION	DIMENSION
60-2003	K-Wire, Open Blades	17 mm
60-2004	V-Wire, Open Blades	17 mm
60-2005	Closed Blades	8 <sup>1</sup> / <sub>2</sub> in

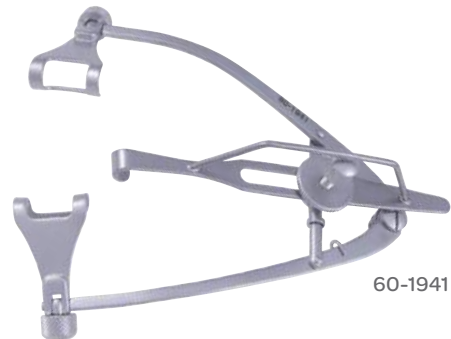

60-1941

### Maumene-Park Speculum

Fenestrated Blades

CODE	BLADE SPREAD	BLADE WIDTH	LENGTH
60-1941	43 mm	14 mm	3 <sup>1</sup> / <sub>4</sub> in 83 mm

## Orthopaedic (Bones)



77-1240

### Aufranc Cobra Retractor

CODE	DESCRIPTION	LENGTH	
77-1242	10 mm, Serrated Blunt Tip	10 ½ in	265 mm
77-1240	10 mm, Serrated Pointed Tip	10 ½ in	265 mm
77-1243	10 mm, Smooth Blunt Tip	10 ½ in	265 mm
77-1241	10 mm, Smooth Pointed Tip	10 ½ in	265 mm



### Aufricht Retractor

CODE	DESCRIPTION	LENGTH	
67-2137FO	7 mm Wide, with Fiber Optic Light Guide and Suction		5 x 95 mm



77-1204

### Bennett Bone Retractor

CODE	WIDTH	LENGTH	
77-1204	45 mm	9 ½ in	240 mm
77-1206	65 mm	9 ½ in	240 mm



### Capsule Retractor

CODE	DESCRIPTION	LENGTH	
77-1005	3 Prong, Sharp, 22 mm Wide	10 in	250 mm

## Orthopaedic (Bones)



### Cobra Retractor

37-4106

CODE	DESCRIPTION	TIP	
37-4106	Blunt	10 ¼ in	260 mm
37-4105	Sharp	10 ¼ in	260 mm



77-1050

### Hohmann Mini Retractor

CODE	WIDTH	LENGTH	
77-1050	6 mm	6 ¼ in	160 mm
77-1052	8 mm	6 ¼ in	160 mm



77-1240

### Hohmann Retractor

CODE	DESCRIPTION	LENGTH	
77-1122	15 mm Wide, without Finger Ring	6 in	150 mm
77-1008	8 mm Wide with Finger Ring	8 ½ in	215 mm
77-1110	10 mm Wide with Finger Ring	8 ¾ in	220 mm
77-1120	16 mm Wide with Finger Ring	9 ½ in	240 mm
77-1118	18 mm Wide with Finger Ring	9 ½ in	240 mm
77-1167	22 mm Wide with Finger Ring	11 in	280 mm
77-1124	24 mm Wide, with Finger Ring	9 ½ in	240 mm
77-1125	25 mm Wide with Finger Ring	9 ½ in	240 mm
77-1142	42 mm Wide with Finger Ring	9 ½ in	240 mm
77-1165	62 mm Wide with Finger Ring	10 in	250 mm



### Murphy-Lane Bone Retractor

CODE	LENGTH
77-1193	12 in 304 mm

## Ophthalmology (Hand)



20-1776

### Hayes Hand Retractor

CODE	WIDTH	LENGTH	
20-1776	3 mm	6 ¼ in	160 mm
20-1777	6 mm	6 ¼ in	160 mm



### House Hand Retractor

CODE	DESCRIPTION	LENGTH	
61-0600	Hand Retractor	6 in	150 mm



### Kasdan Hand Retractor

CODE	DESCRIPTION	LENGTH	
20-0540	Double-Ended	6 ¼ in	160 mm

## Orthopaedic (Hand-Held)



### McElroy Angulated Retractor

CODE	DESCRIPTION	LENGTH	
77-1191	T-Handle Retractor, 5 in (120 mm) Blade Depth	7 in	178 mm

## Orthopaedic (Hip)

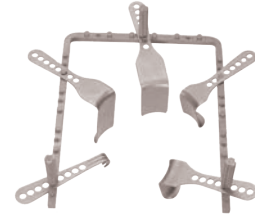

30-038-000

### Complete Charnley Retractor Set

CODE	DESCRIPTION	QTY
30-038-000	Charnley Retractor Set, Includes the Following:	
13-045-008	Standard Charnley Retractor Frame	1
13-045-001	Standard Charnley Retractor	2
13-045-002	Large Standard Charnley Retractor	2
13-045-003	Serrated Charnley Retractor Blade	2
13-045-004	Threaded Locking Screw	6
13-045-000	Optional Frame: Small Charnley Retractor Frame	1



30-034-000

### Complete Hip Retractor System

CODE	DESCRIPTION
30-034-000	Hip Retractor System, includes the following:
13-023-000	Hip Retractor, 25 mm Blade Part
13-024-000	Hip Retractor, Blunt Tip
13-025-000	Offset Retractor, 32 mm Blade
13-026-000	Long Hohmann
13-027-000	Long Hohmann, Curved, Short Blade
13-028-000	Long Hohmann, Curved, Long Blade
13-029-000	Small Hohmann
13-031-000	Femoral Elevator
11-078-000	Hybrid Case



### Blount Hip Retractor

77-1251

CODE	DESCRIPTION	LENGTH
77-1251	Single Prong	10 in 250 mm
77-1252	Double Prong	10 in 250 mm

## Orthopaedic (Hip)



### Charnley Initial Incision Retractor

24-2000

CODE	DESCRIPTION
24-2000	Complete set
24-2000C	Chain
24-2000CW	Chain with Weight



### Charnley Retractor Blade

CODE	DESCRIPTION	LENGTH	DEPTH
24-2019A	Short Angled	1 in	1 in
24-2014	Short Angled	1 in	2 in
24-2004A	Short Angled	1 in	2½ in
24-2022A	Short Angled	1 in	3 in
24-2009A	Short Angled	1 in	4 in
24-2010A	Long Angled	1 in	4 in
24-2005A	Long Angled	1 in	2½ in
24-2016A	Long Angled	1 in	3 in
24-2010A	Long Angled	1 in	4 in
24-2012	Short Rounded	1 in	¼ in
24-2004	Short Rounded	1 in	2½ in
24-2009	Short Rounded	1 in	4 in
24-2009M	Short Rounded	1 in	6 in
24-2011	Long Rounded	1 in	1½ in
24-2017	Long Rounded	1 in	1½ in
24-2005	Long Rounded	1 in	2½ in
24-2010	Long Rounded	1 in	4 in



## Orthopaedic (Hip)



13-023-000

### Minimally Invasive Hip Retractor

CODE	SIZE	DESCRIPTION
13-023-000	#1, Curved	25 mm Blade Pointed Tip
13-024-000	#2, Curved	Blunt Tip
13-025-000	#3, Offset	32 mm Blade
13-026-000	#4	Long Hohmann
13-027-000	#5	Long Hohmann, Short Curved Blade
13-029-000	#7	Long Hohmann, Narrow Blade
13-030-000	#8	Small Hohmann

## Orthopaedic (Hip & Shoulder)



### Meyerding Hip & Shoulder Skid

CODE	LENGTH
77-1190	13 in 329 mm

## Orthopaedic (Humeral)



### Bristow-Bankart Humeral Retractor

CODE	DESCRIPTION	DIMENSIONS
77-1011	2 Prong, Blunt	25 x 102 mm

## Orthopaedic (Humeral Head)



### Humeral Head Retractor

CODE	WIDTH	LENGTH
77-1013	18 mm	8 ¾ in 200 mm

## Orthopaedic (Knee)



13-035-000

### Minimally Invasive Knee Retractor

CODE	SIZE	DESCRIPTION
30-032-000		System includes the following:
13-035-000	#1	Small Hohmann
13-036-000	#2	Large Hohmann
13-037-000	#3	Condylar Retractor
13-038-000	#4	Superior Retractor
13-039-000	#5	Patellar Retractor
13-040-000	#6	Collateral Retractor, Left
13-041-000	#7	Collateral Retractor, Right
13-042-000	#8	Soft Tissue Retractor



### Worland PCL Retractor

CODE	DESCRIPTION	LENGTH
13-001-000	13 mm Tip	12 ½ in 316 mm

## Orthopaedic (Knee)



78-5998

### Doane "Z" Knee Retractor

CODE	DESCRIPTION	DIMENSIONS	LENGTH
78-5998	Double-Ended	11 x 57 x 69 mm	152 mm
78-5999	Double-Ended	11 x 63 x 76 mm	152 mm



77-1189

### Hohmann Knee Retractor

CODE	DESCRIPTION	LENGTH
77-1189	Up 90°	16 in 405 mm
77-1188	Up 120°	16 in 405 mm



77-5621

### Smillie Knee Retractor

CODE	DESCRIPTION W X D	LENGTH
77-5610	13 x 18 mm	5 ½ in 140 mm
77-5611	13 x 25 mm	5 ½ in 140 mm
77-5621	13 x 55mm, Double Curved	5 ½ in 140 mm
77-5601	19 x 30 mm	5 ½ in 140 mm
77-5602	19 x 45 mm	5 ½ in 140 mm
77-5603	19 x 60 mm	5 ½ in 140 mm

## Orthopaedic (Shoulder)



Fukuda Shoulder Retractor

77-1006

CODE	DESCRIPTION	LENGTH	
77-1006	38 x 81 mm	7 in	178 mm
77-1007	32 x 81 mm	7 in	178 mm

## Plastic Surgery (Brow Lift)



22-2008

Corneal Brow Lift Retractor

CODE	DESCRIPTION	LENGTH	
22-2008	7 Prong	7 in	178 mm
20-2010	7 Prong, Sharp	7 in	178 mm

## Plastic Surgery (Hand)



Tip



20-6103

Plastic/Hand Surgery Retractor

CODE	DESCRIPTION	LENGTH	
20-6101	1 Prong, Blunt	6¾ in	170 mm
20-6102	2 Prong, Blunt	6¾ in	170 mm
20-6103	3 Prong, Blunt	6¾ in	170 mm
20-6104	4 Prong, Blunt	6¾ in	170 mm

## Plastic Surgery (Hand)



20-6004

### Plastic/Hand Surgery Retractor

CODE	DESCRIPTION	WIDTH	LENGTH
20-6001	1 Prong, Sharp	9 mm	6 <sup>3</sup> / <sub>4</sub> in 170 mm
20-6002	2 Prong, Sharp	5 mm	6 <sup>3</sup> / <sub>4</sub> in 170 mm
20-6003	3 Prong, Sharp	8 mm	6 <sup>3</sup> / <sub>4</sub> in 170 mm
20-6004	4 Prong, Sharp	11 mm	6 <sup>3</sup> / <sub>4</sub> in 170 mm

## Plastic Surgery (Hand-Held)



### Anderson Bear Claw Retractor

CODE	DESCRIPTION	LENGTH
22-2005	5 Prong	4 <sup>3</sup> / <sub>4</sub> in 120 mm

## Prostatic



51-9503



51-9504

### Young Prostatic Retractor

CODE	DESCRIPTION	DIMENSIONS	LENGTH
51-9501	Lateral Notched Blade	<sup>7</sup> / <sub>16</sub> x 2 in 11 x 50 mm	8 <sup>1</sup> / <sub>4</sub> in 210 mm
51-9503	Notched Blade	1 x 1 in 25 x 25 mm	8 <sup>1</sup> / <sub>4</sub> in 210 mm
51-9504	Bifurcated Blade	1 <sup>3</sup> / <sub>4</sub> x 1 <sup>1</sup> / <sub>2</sub> in 44 x 38 mm	8 <sup>1</sup> / <sub>4</sub> in 210 mm

## Rectal (Hand-Held)



### Barr Anal Retractor

CODE	DESCRIPTION	DIMENSIONS	LENGTH
50-7325	Self-Retaining with Blades	2 3/4 x 7/8 in 70 x 22 mm	8 in 200 mm

## Rectal (Self-Retaining)



50-7615

### Brinkerhoff Rectal Speculum

CODE	DESCRIPTION	DIMENSIONS	LENGTH
50-7613	Small	1/2 in x 1 in 12 x 25 mm	4 1/2 in 114 mm
50-7615	Medium	5/8 x 1 in 15 x 25 mm	4 1/2 in 114 mm
50-7619	Large	3/4 x 1 1/4 in 19 x 31 mm	4 1/2 in 114 mm

## Rectal (Bookwalter®)

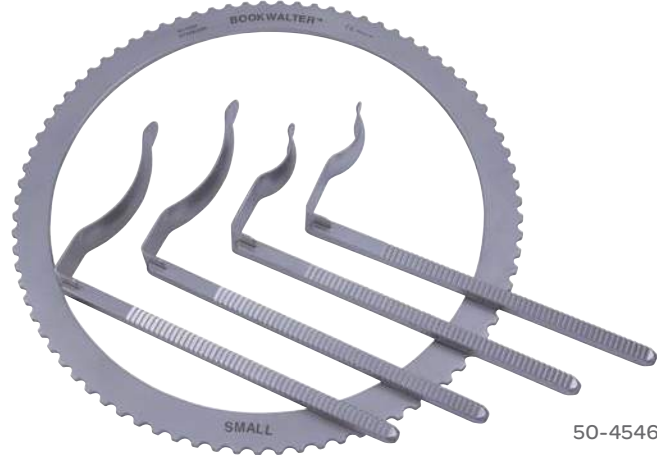

### Bookwalter® Rectal Accessory Kit

Kit Includes: 1 Ring and 2 Blades

50-4546

CODE	DESCRIPTION	DIAMETER	BLADE	DIMENSIONS
50-4546	Kit Includes the Following:			
50-4584	Bookwalter® Round Rings, Small	8½ in 216 mm		
50-4585	Bookwalter® Rectal Blade, Small		2⅞ in 73 mm	3 x 7 in 76 x 178 mm
50-4586	Bookwalter® Rectal Blade, Large		3⅞ in 98 mm	4 x 6 in 101 x 152 mm

Note: Use of this product requires a Bookwalter® Table Post, Bookwalter® Coupler, Bookwalter® Horizontal Bar, and Bookwalter® Ratchet (not included in this accessory set.)

## Rectal



50-9604

### Hill-Ferguson Rectal Retractor

CODE	DIMENSIONS	LENGTH
50-9604	⅞ x ¼ in 22 x 6 mm	8 in 200 mm
50-9605	⅞ x 3 in 3 x 76 mm	8½ in 215 mm
50-9606	3 x 1⅜ in 76 x 35 mm	8½ in 215 mm
50-9607	1½ in 38 mm	8½ in 215 mm

## Rectal



50-9621

### Sawyer Retractor

CODE	DESCRIPTION	BLADE DIMENSIONS		LENGTH	
50-9621	Retractor	1 $\frac{1}{8}$ x 3 in	28 x 76 mm	11 in	280 mm
50-9622	Retractor	1 $\frac{1}{2}$ x 3 $\frac{1}{2}$ in	38 x 89 mm	11 in	280 mm



### Smith-Buie Rectal Retractor

CODE	DESCRIPTION	LENGTH
50-7420	Self-Retaining, with Swivel Blades	4 $\frac{1}{2}$ in 115 mm

## Redundant Wall



### Redundant Wall Retractor

CODE	DESCRIPTION	BLADE DIMENSIONS	
52-0790	Wall Retractor	$\frac{3}{4}$ x 5 in	19 x 127 mm



## Renal (Sinus)



5150-D

### Gilvernet Renal Retractor

CODE	DESCRIPTION	LENGTH	CODE	DESCRIPTION	LENGTH
5150-A	9 mm	11¼ in 286 mm	5150-C	15 mm	11¼ in 285 mm
5150-B	11 mm	11¼ in 286 mm	5150-D	18 mm	11¼ in 285 mm

## Renal (Vein)



54-1795

### Wylie Renal Retractor

CODE	DESCRIPTION	BLADE WIDTH
54-1795	Renal Retractor	1 x 4 in 25 x 102 mm
54-1797	Renal Retractor	1 x 7 in 25 x 178 mm

## Renal



58-0084

### Universal Ring Wiley Renal Retractor Blade

CODE	DESCRIPTION	DIMENSIONS
58-0084	Renal Retractor Blade	1 x 7 in 25 x 178 mm
58-0084L	Renal Retractor Blade	1 x 11 in 25 x 279 mm

## Rib (Self-Retaining)

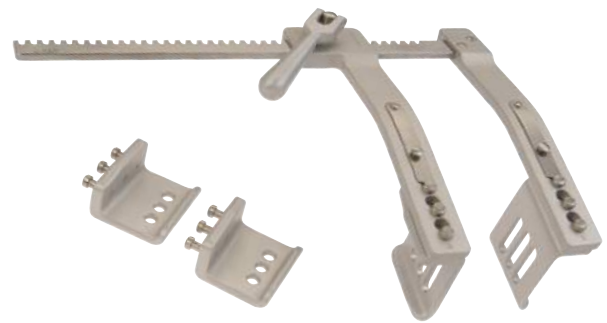

50-8033

### Burford-Finochietto Rib Retractor

CODE	DESCRIPTION	TOTAL OPENING		BLADE	ARM LENGTH		LENGTH	
50-8133	Child Model, Self Retaining with Rack and Pinion Action, Aluminum	6 in	152 mm	Large: $1\frac{5}{8} \times 1\frac{7}{8}$ in 41 x 48 mm Small: $1\frac{5}{8} \times 1\frac{3}{8}$ in 41 x 35 mm	6 in	152 mm	6 in	152 mm
50-8033	Self-Retaining, Two Sets of Detachable Blades, Curved Arms	10 in	254 mm	Large: $2\frac{1}{2} \times 2\frac{5}{8}$ in 64 x 67 mm Small: $2\frac{1}{2} \times 1\frac{3}{4}$ in 64 x 44 mm	$9\frac{1}{2}$ in	241 mm	10 in	254 mm
50-8031	Self-Retaining, Two Sets of Detachable Blades, Curved Arms	10 in	254 mm	Large: $2\frac{1}{2} \times 2\frac{4}{5}$ in 64 x 71 mm Small: $2\frac{1}{2} \times 1\frac{3}{5}$ in 64 x 41 mm	$9\frac{3}{4}$ in	248 mm	10 in	254 mm

## Rib



54-2101

### Cooley Rib Retractor

Aluminum Arms and Blades

CODE	DESCRIPTION	BLADE LENGTH		BLADE DEPTH		SPREAD		ARM LENGTH	
54-2101	Pediatric	1 in	25 mm	$\frac{5}{8}$ in	16 mm	$4\frac{3}{4}$ in	121 mm	$3\frac{1}{8}$ in	79 mm
54-2100	Adult	$1\frac{3}{8}$ in	35 mm	$1\frac{3}{8}$ in	35 mm	7 in	178 mm	$4\frac{1}{4}$ in	108 mm

## Rib



### Finochietto Rib Retractor

Self-Retaining with Rack and Pinion Action

50-5625

CODE	DESCRIPTION	TOTAL OPENING	BLADE (W X D)	ARM LENGTH	LENGTH
50-5625	Infant	2½ in 64 mm	¾ x 1⅜ in 19 x 30 mm	3 in 76 mm	2½ in 64 mm
50-8022	Pediatric	6½ in 165 mm	1¾ x 1¾ in 44 x 44 mm	6 in 152 mm	6 in 152 mm



### Haight-Finochietto Rib Retractor

Self-Retaining with Rack and Pinion Action

CODE	DESCRIPTION	TOTAL OPENING	BLADE (W X D)	ARM LENGTH	LENGTH
50-8028	Rib Retractor	4 in 102 mm	1¼ x 1⅜ in 32 x 30 mm	3¼ in 83 mm	4 in 102 mm

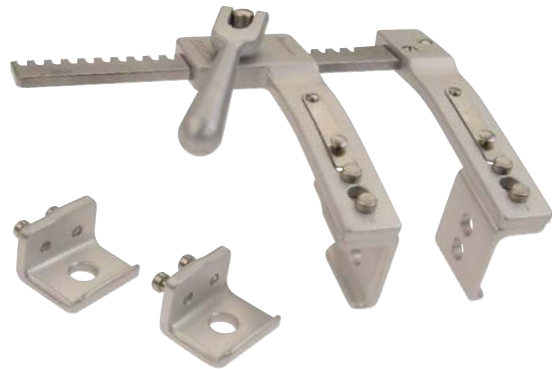

### Rib Retractor

Infant, Self-Retaining with Rack and Pinion Action, Aluminum

CODE	ARM LENGTH	BLADE WIDTH	BLADE DEPTH	LENGTH
50-5625	3 in 76 mm	¾ in 19 mm	⅜ in 21 mm	2½ in 64 mm

## Rib



50-8065

## Tuffier Rib Retractors

Self-Retaining

CODE	DESCRIPTION	LENGTH	
50-8065	Roughened Blades	3 x 2 1/2 in	76 x 64 mm
50-8064	Serrated Blades	4 3/4 x 6 in	146 x 152 mm

## Scalp



## Anderson-Adson Scalp Retractor

Angular Arms

CODE	DESCRIPTION	BLADE WIDTH	BLADE DEPTH	TOTAL OPENING	LENGTH
50-1186	4 x 4 Sharp Prongs	3/4 in 19 mm	5/8 in 16 mm	4 1/2 in 114 mm	7 1/2 in 191 mm

## Scalp

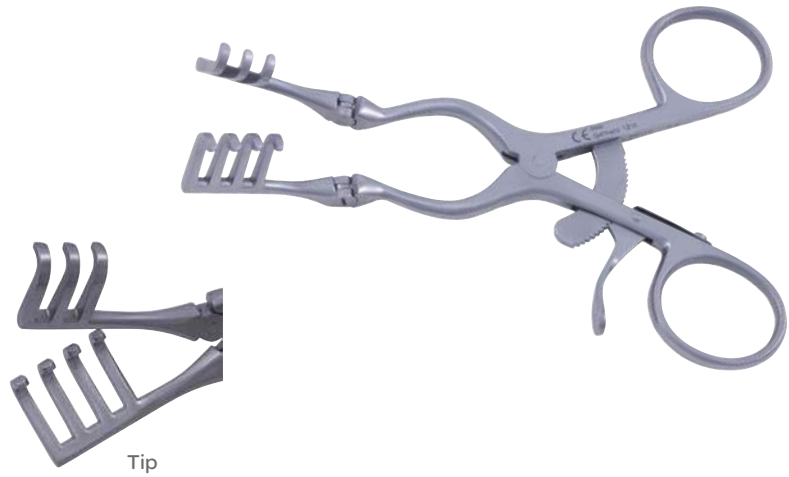

### Cone Scalp Retractor

CODE	DESCRIPTION	LENGTH
50-1166	Self-Retaining with Hinged Arms, 3 x 4 Prong, Blunt	5 <sup>3</sup> / <sub>4</sub> in 146 mm



24-2670

### Contour Scalp Retractor

CODE	DESCRIPTION	LENGTH
24-2670	Angled Arms, 3 x 4 Prong, Blunt	5 <sup>1</sup> / <sub>2</sub> in 139 mm
24-2671	Angled Arms, 3 x 4 Prong, Sharp	5 <sup>1</sup> / <sub>2</sub> in 139 mm
50-1220	5/8 x 5/8 in, Total Opening 2 <sup>1</sup> / <sub>2</sub> in	5 <sup>1</sup> / <sub>2</sub> in 139 mm

## Scalp



24-1310

## Jansen Scalp Retractor

CODE	DESCRIPTION	LENGTH	
24-1310	3 x 3 Prong, Sharp	4 in	100 mm
24-1320	3 x 3 Prong, Blunt	4 in	100 mm
24-1321	4 x 4 Prong, Blunt	4 $\frac{3}{8}$ in	112 mm
50-1226	4 x 4 Prong, Blunt, Self Retaining	4 $\frac{5}{8}$ in	117 mm

## Scapula

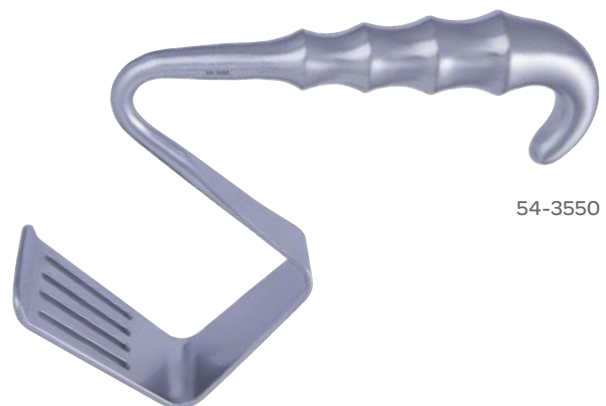

54-3550

## Davidson Scapular Retractor

CODE	HANDLE LENGTH		BLADE WIDTH		BLADE DEPTH	
54-3550	6 in	152 mm	2 in	51 mm	3 in	76 mm
50-8096	6 in	152 mm	3 $\frac{1}{2}$ in	89 mm	3 in	76 mm

## Septum



79-7011

### Killian Septum Specula & Killian Septum Speculum

Self-Retaining

CODE	BLADES	LENGTH
79-7011	51 mm	5 ¼ in 133 mm
79-7012	63 mm	5 ¼ in 133 mm
79-7013	76 mm	5 ¼ in 133 mm
63-6265	51 mm	6 in 152 mm
63-6266	64 mm	6 in 152 mm
63-6267	76 mm	6 in 152 mm
63-6268	90 mm	6 in 152 mm

## Spine (Crockard™)



### Crockard™ Transoral Instrument Case

CODE	DIMENSIONS
50-1664	18 x 10 ½ x 7 ¼ in 457 x 266 x 184 mm

## Spine (Crockard™)



### Crockard™ Transoral Instrument Set

CODE	DESCRIPTION	QTY
50-1651	1 Crockard™ Transoral Retractor Body	1
50-1652	1 Large Tongue Retractor Blade	1
50-1653	1 Small Tongue Retractor Blade	1
50-1654	2 Crockard™ 90 Degree Retractor Blade	2
50-1655	2 Crockard™ Curved Retractor	2
50-1656	2 Crockard™ Connector Blades	2
50-1657	1 Crockard™ Suction Tube Short	1
50-1658	1 Crockard™ Suction Tube Long	1
50-1659	1 Crockard™ Hard Palate Retractor	1
50-1660	1 Pharyngeal Retractor Small	1
50-1661	1 Pharyngeal Retractor Large	1
50-1662	1 Crockard™ Odontoid Peg Grasping Forceps	1
50-1663	1 Crockard™ Ligament Grasping Forceps	1
50-1664	1 Crockard™ Sterilizing and Storage Case	1



## Spine (Crockard™)



### Crockard™ Hard Palate Retractor

CODE	DESCRIPTION	LENGTH
50-1659	Hard Palate Retractor	90 x 75 mm



### Crockard™ Mid-Facial Osteotomy Retractor Plate

CODE	DESCRIPTION	LENGTH
50-1668	Mid-Facial Osteotomy Retractor Plate	6 in 152 mm



50-1660

### Crockard™ Pharyngeal Retractor

CODE	DESCRIPTION
50-1660	Small
50-1661	Large

## Spine (Cervical)

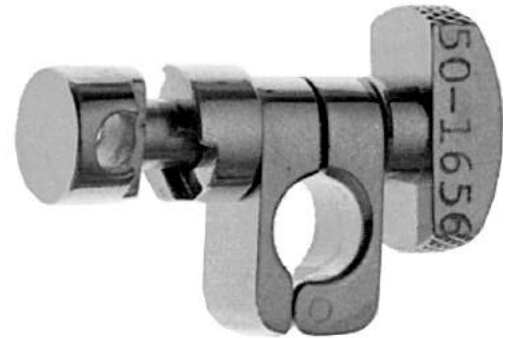

### Crockard™ Pharyngeal Retractor

CODE	DESCRIPTION
50-1656	Crockard™ Retractor Blade Connector

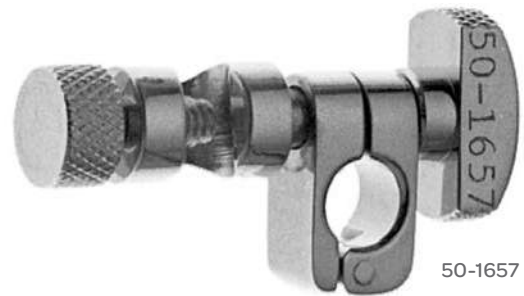

### Crockard™ Suction Tube Holder

CODE	DESCRIPTION
50-1657	Short
50-1658	Long



### Crockard™ Tongue Retractor Blade

CODE	DESCRIPTION
50-1653	Small
50-1652	Large

## Spine (Cervical)



### Crockard™ Transoral Retractor Body

CODE	DESCRIPTION
50-1651	Transoral Retractor Body



### Cervical Retractor Set

CODE	DESCRIPTION	LENGTH
50-1390	Small, Self-Retaining with 7 Pairs of Blunt Blades	6 x 3 3/4 in 152 x 95 mm



### Cervical Retractor

CODE	DESCRIPTION	LENGTH
50-1380	Large, Self-Retaining with Seven Pairs of Sharp Blades Total Opening: 4 1/2 in (114mm)	10in 254mm
57-5660	Hinged Frame, 90 mm Spread	
57-5662	Hinged Frame Only, Hinged Arms, 90 mm Spread	
57-5661	Hinged Frame Only, Rigid Arms	
57-5659	Rigid Frame	
57-5550	One Prong, Blunt	

## Spine (Cervical)



50-1383

### Cervical Retractor Blade

Sharp, Four Prong, for use with 50-1380

CODE	DESCRIPTION
50-1381	25 mm Blade
50-1382	30 mm Blade
50-1383	35 mm Blade
50-1384	40 mm Blade
50-1385	45 mm Blade
50-1386	50 mm Blade
50-1387	55 mm Blade



50-1392

### Cervical Retractor Blade

Blunt, for use with 50-1390

CODE	DESCRIPTION
50-1391	25 mm
50-1392	30 mm
50-1393	35 mm
50-1394	40 mm
50-1395	45 mm
50-1396	50 mm
50-1397	55 mm

## Spine (Cervical)



57-5511

### Cervical Retractor Blades, Medial with Teeth

Carbon Fiber Radiolucent Blades, Ball Snap Closure, for Use with Cervical Retractors: 57-5659, 57-5660, 57-5661 and 57-5662.

CODE	DESCRIPTION
57-5510	40 x 23 mm
57-5511	45 x 23 mm
57-5512	50 x 23 mm
57-5513	55 x 23 mm
57-5514	60 x 23 mm
57-5515	65 x 23 mm

### Cervical Retractor Blades, Lateral with Teeth

Carbon Fiber Radiolucent Blades, Ball Snap Closure

CODE	DESCRIPTION
57-5516	40 x 23 mm
57-5517	45 x 23 mm
57-5518	50 x 23 mm
57-5520	55 x 23 mm
57-5521	60 x 23 mm
57-5519	65 x 23 mm

## Spine (Cervical)



57-5523

### Cervical Retractor Blades, Longitudinal Blades, Blunt

Carbon Fiber Radiolucent Blades, Ball Snap Closure

CODE	DESCRIPTION
57-5522	40 x 23 mm
57-5523	45 x 23 mm
57-5524	50 x 23 mm
57-5525	55 x 23 mm
57-5526	60 x 23 mm
57-5527	65 x 23 mm



57-5530

### Cervical Retractor Blades

Stainless Steel, Ball Snap Closure, Longitudinal Blades, Blunt

CODE	DESCRIPTION
57-5530	40 x 23 mm
57-5531	45 x 23 mm
57-5532	50 x 23 mm
57-5533	55 x 23 mm
57-5534	60 x 23 mm

### Cervical Retractor Blades

Stainless Steel, Ball Snap Closure, Fenestrated Blades, Blunt

CODE	DESCRIPTION
57-5535	50 x 25 mm
57-5536	60 x 25 mm

## Spine (Cervical)



57-5665

### Cervical Retractor Blade

Stainless Steel, Ball Snap Closure, for use with 57-5759, 57-5760, 57-5761 and 57-5762

CODE	DESCRIPTION
57-5665	Medial Blades with Teeth 40 x 23 mm
57-5666	Medial Blades with Teeth 45 x 23 mm
57-5667	Medial Blades with Teeth 50 x 23 mm
57-5668	Medial Blades with Teeth 55 x 23 mm
57-5669	Medial Blades with Teeth 60 x 23 mm
57-5665L	Lateral Blades with Teeth 40 x 23 mm
57-5666L	Lateral Blades with Teeth 45 x 23 mm
57-5667L	Lateral Blades with Teeth 50 x 23 mm
57-5668L	Lateral Blades with Teeth 55 x 23 mm
57-5669L	Lateral Blades with Teeth 60 x 23 mm



50-1356

### Cervical Retractor Body

CODE	DESCRIPTION
50-1356	Small
50-1346	Large

## Spine (Cervical)



### Cervical Retractor

CODE	DESCRIPTION	LENGTH
57-5602	Double-Hinge Retractor	45 x 23 mm

## Spine (Decompression)



### Cushing Decompression Retractor

57-5205

CODE	DESCRIPTION	LENGTH
57-5205	Fenestrated	8 in 203 mm

## Spine (Dural)



### 90° Dural Suction Retractor

46-3012

CODE	WORKING DISTANCE	TIP WIDTH	TIP DEPTH
46-3012	4 <sup>3</sup> / <sub>4</sub> in 120 mm	<sup>9</sup> / <sub>32</sub> in 8 mm	<sup>1</sup> / <sub>4</sub> in 6 mm
46-3013	4 <sup>3</sup> / <sub>4</sub> in 120 mm	<sup>3</sup> / <sub>8</sub> in 9.5 mm	<sup>1</sup> / <sub>4</sub> in 6 mm
46-3014	5 <sup>3</sup> / <sub>4</sub> in 146 mm	<sup>1</sup> / <sub>4</sub> in 6 mm	<sup>1</sup> / <sub>4</sub> in 6 mm
46-3015	5 <sup>3</sup> / <sub>4</sub> in 146 mm	<sup>3</sup> / <sub>8</sub> in 9.5 mm	<sup>1</sup> / <sub>4</sub> in 6 mm



## Spine (Dural)



### Dural Retractor

CODE	DESCRIPTION	LENGTH
50-1105	Self-Retaining with Three Malleable Blades, 4 in 102 mm Blade Widths: 11 mm, 13 mm, 15 mm	8¼ in 210 mm

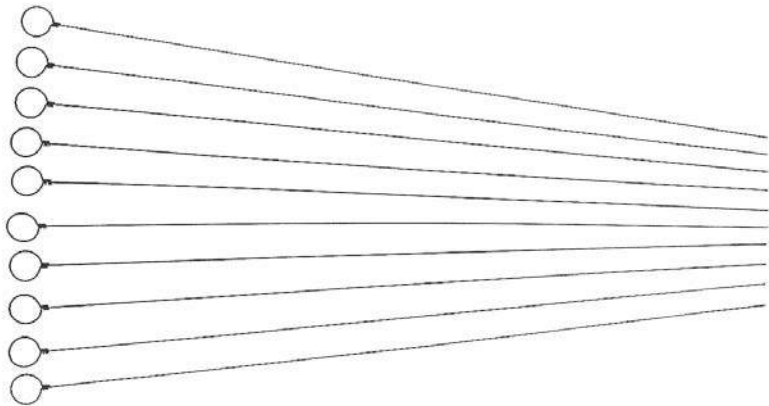

### Wire Styles

CODE	DESCRIPTION
46-4000	Used with Dural Suction Retractors for Cleaning and Storage

## Spine (Hand-Held)



### Blade Retractor With Lip

57-5498

Add "M" to Code Number for Blade without Lip

CODE	DESCRIPTION	LENGTH	
57-5497	13 mm	7½ in	191 mm
57-5498	18 mm	7½ in	191 mm
57-5499	20 mm	7½ in	191 mm
57-5500	23 mm	7½ in	191 mm



63-4017

### Converse Blade Retractor

CODE	DESCRIPTION	LENGTH	
63-4017	9 x 18 mm	3¾ in	95 mm
63-4018	12 x 21 mm	3¾ in	95 mm
63-4019	12 x 38 mm	3¾ in	95 mm
63-4020	12 x 53 mm	3¾ in	95 mm

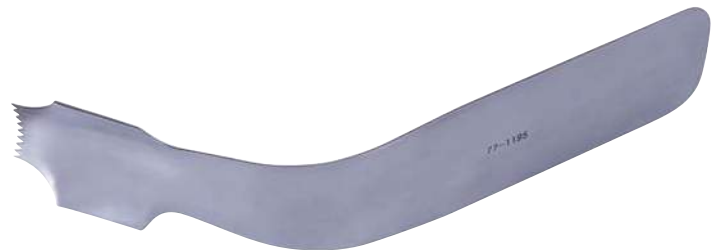

### Goldstein Neck Retractor

CODE	DESCRIPTION	LENGTH	
77-1195	Neck Retractor	8½ in	215 mm

## Spine (Hand-Held)



50-1085

### Taylor Spinal Retractor

CODE	DESCRIPTION	DIMENSIONS	
57-5407	32 x 75mm	6 <sup>3</sup> / <sub>4</sub> in	171 mm
57-5408	20 x 75mm	6 <sup>3</sup> / <sub>4</sub> in	171 mm
57-5410	32 x 100mm	6 <sup>3</sup> / <sub>4</sub> in	171 mm
57-5413	31 x 152mm	6 <sup>3</sup> / <sub>4</sub> in	171 mm
50-1085	30 x 76mm	7 <sup>1</sup> / <sub>4</sub> in	184 mm
50-1086	32 x 102mm	7 <sup>1</sup> / <sub>4</sub> in	184 mm

## Spine (Hand-Held Retractor Set)



### Sofield Hand Held Retractor Set

CODE	DESCRIPTION	BLADE LENGTH	HANDLE LENGTH	
32-3660	Double-Ended, Set of 6			
32-3667		Clip	5 in	127 mm
32-3666		114 x 13mm	7 <sup>1</sup> / <sub>2</sub> in	191mm
32-3665		102 x 19mm	8 in	203mm
32-3664		89 x 16mm	8 <sup>1</sup> / <sub>16</sub> in	204mm
32-3662		70 x 13mm	8 <sup>1</sup> / <sub>8</sub> in	206mm
32-3661		63 x 13mm	8 <sup>1</sup> / <sub>4</sub> in	210mm

## Spine (Hemilaminectomy)



### Valin Hemilaminectomy Retractor Set

Self-Retaining with Rack and Pinion Action

CODE	DESCRIPTION	TOTAL OPENING
50-1120	Includes the Following: 50-1121: Body, 13-1004C: 2 in Retractor Hook, 13-1008: 1 x 2½ in Retractor Blade	4½ in 114 mm



24-4590

### Markham-Meyerding Hemilaminectomy Retractor

CODE	DESCRIPTION	DIMENSIONS
24-4591	Blades On Left Arm	25 x 30mm 7¼ in 184mm
24-4590	Blades On Right Arm	25 x 30mm 7¼ in 184mm
50-1205	Self-Retaining, Left	25 x 51mm 7 in 178 mm
50-1206	Self-Retaining, Right	25 x 51mm 7 in 178 mm

## Spine (Lamina)

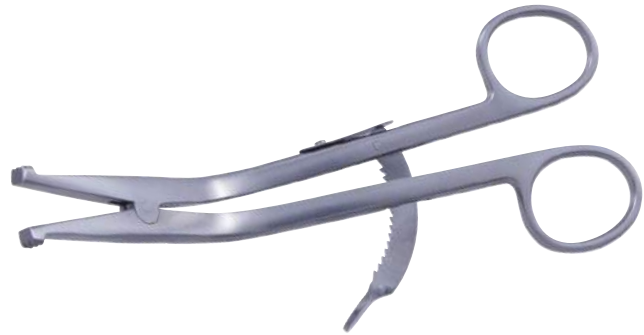

### Cloward Lamina Retractor

CODE	DESCRIPTION
57-5575	With Ratchet

## Spine (Laminectomy)



### Badgley Laminectomy Retractor

Self-Retaining

CODE	TOTAL OPENING	BLADE
50-1255	6 <sup>3</sup> / <sub>8</sub> in 162 mm	1 <sup>3</sup> / <sub>4</sub> x 2 in 44 x 51



50-1160

### Beckman-Adson Laminectomy Retractor

Self-Retaining with Hinged Arms

CODE	DESCRIPTION	BLADE	TOTAL OPENING	LENGTH
50-1161	Sharp	1 in 25 mm	5 in 127 mm	12 in 305 mm
50-1160	Blunt	1 x 1 <sup>1</sup> / <sub>4</sub> in 25 x 32 mm	5 in 127 mm	12 in 305 mm
50-1162	Blunt	1 x 1 in 25 x 25 mm	5 <sup>1</sup> / <sub>2</sub> in 140 mm	12 in 305 mm

## Spine (Laminectomy)



50-1167

### Cone Laminectomy Retractor

Self-Retaining, Hinged Arms

CODE	DESCRIPTION	LENGTH
50-1167	3 x 4 Prongs, Sharp	6 <sup>3</sup> / <sub>8</sub> in 162 mm
50-1168	3 x 4 Prongs, Sharp	8 in 203 mm



50-1190

### Meyering Laminectomy Retractor

Self-Retaining

CODE	BLADE	TOTAL OPENING	LENGTH
50-1190	1 in x 2 <sup>1</sup> / <sub>4</sub> in 25 x 57 mm	3 <sup>3</sup> / <sub>4</sub> in 95 mm	6 <sup>1</sup> / <sub>2</sub> in 165 mm
50-1191	1 in x 2 in 25 x 51 mm	3 <sup>3</sup> / <sub>4</sub> in 95 mm	6 <sup>1</sup> / <sub>2</sub> in 165 mm
50-1192	1 in x 1 <sup>3</sup> / <sub>4</sub> in 25 x 41 mm	3 <sup>3</sup> / <sub>4</sub> in 95 mm	6 <sup>1</sup> / <sub>2</sub> in 165 mm



50-1065

### Meyering Laminectomy Retractor

CODE	DESCRIPTION	BLADE	LENGTH
50-1065	Small, Hand Held	<sup>5</sup> / <sub>8</sub> x 2 in 16 x 51 mm	9 in 229 mm
50-1066	Medium, Hand Held	1 x 3 in 25 x 76 mm	9 <sup>1</sup> / <sub>2</sub> in 241 mm
50-1067	Large, Hand Held	2 x 3 <sup>1</sup> / <sub>2</sub> in 51 x 89 mm	9 <sup>1</sup> / <sub>2</sub> in 241 mm

## Spine (Laminectomy)



### Poppen-Gelpi Laminectomy Retractor

CODE	DESCRIPTION	TOTAL OPENING	LENGTH
50-1212	Self-Retaining	2½ in 64 mm	5½ in 140 mm



### Seletz-Gelpi Laminectomy Retractor

With Arms Bent at Right Angles

CODE	DESCRIPTION	ARM LENGTH	TOTAL OPENING	LENGTH
50-1211	Self-Retaining	2¾ in 65 mm	3¾ in 95 mm	6¼ in 159 mm

## Spine (Lumbar)



### Caspar Lumbar Speculum

57-5646

CODE	DESCRIPTION
57-5646	40 mm
57-5647	45 mm
57-5648	50 mm
57-5649	55 mm
57-5650	60 mm

## Spine (Karlin™)

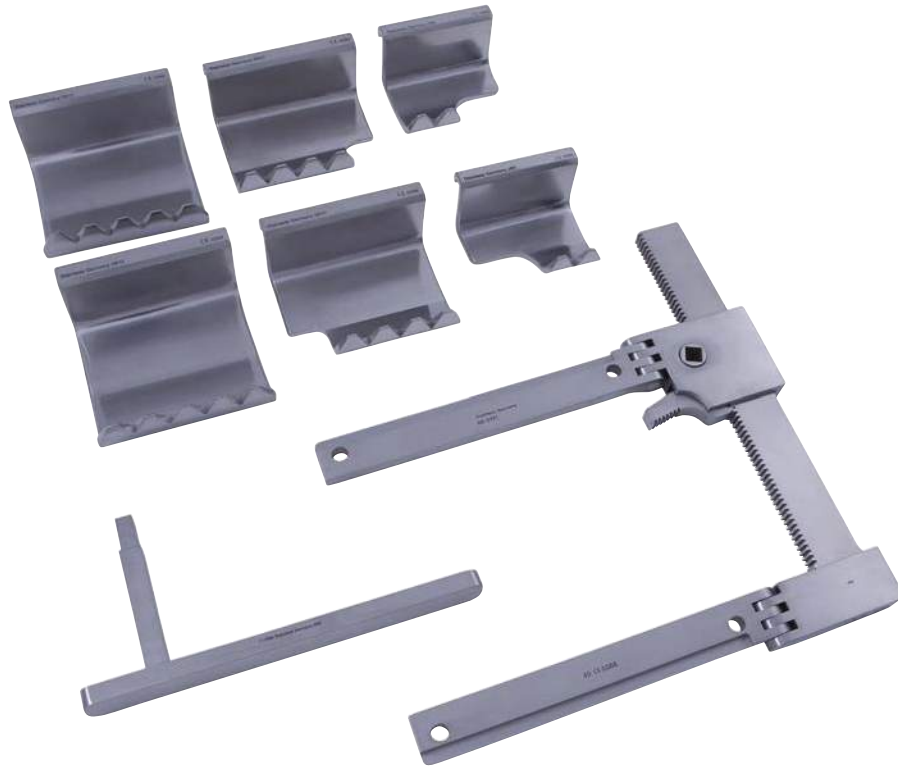

## Karlin™ Crank Frame Spinal Retractor Set

CODE	DESCRIPTION	LENGTH
46-3190	Designed for posterior Lumbar and Thoracic spine surgery. Arm design allows the blades to be pre-positioned in the wound prior to attachment. Blades are interchangeable. Multiple blades may be used on each retractor arm. Maximum width opening 5½ in (140 mm) Crank Frame Spinal Retractor Set Includes:	2¼ x 2½ in 57 x 64 mm
46-3191	Crank Frame Retractor Body	
46-3192	Crank Frame Retractor Ratchet	
46-3193	Blade with Sacral Cutout, Left	1¼ x 1½ in 31 x 38 mm
46-3194	Blade with Sacral Cutout, Right	1¼ x 1½ in 31 x 38 mm
46-3195	Blade with Sacral Cutout, Left	2¼ x 1¾ in 57 x 44 mm
46-3196	Blade with Sacral Cutout, Right	3 x 2½ in 57 x 44 mm
46-3197	Blade, Left/Right (2 Blades in Set, 1 with re-order)	1¼ x 1½ in 76 x 64 mm



## Spine (Karlin™)



46-3202

### Karlin™ Crank Frame Retractor Blade

Left and Right Pair, Offset

CODE	DESCRIPTION	DIMENSIONS
46-3199		$\frac{3}{4}$ x 1 $\frac{1}{4}$ in
46-3200		$\frac{3}{4}$ x 1 $\frac{3}{4}$ in
46-3201		$\frac{3}{4}$ x 2 $\frac{1}{4}$ in
46-3202		$\frac{3}{4}$ x 3 in
46-3203		$\frac{3}{4}$ x 3 $\frac{1}{4}$ in
46-3204		$\frac{3}{4}$ x 4 in
46-3205	Not Offset	2 x 4 in

## Spine (Micro Discectomy)



57-2952

### Micro Discectomy Retractor

Self-Retaining

CODE	DESCRIPTION	LENGTH	TOTAL LENGTH
57-2951	Left Hook	50 x 10 mm	6 in 152 mm
57-2952	Left Hook	50 x 20 mm	6 in 152 mm
57-2961	Left Hook	60 x 10 mm	6 in 152 mm
57-2962	Left Hook	60 x 20 mm	6 in 152 mm
57-2971	Left Hook	70 x 10 mm	6 in 152 mm
57-2972	Left Hook	70 x 20 mm	6 in 152 mm
57-2851	Right Hook	50 x 10 mm	6 in 152 mm
57-2852	Right Hook	50 x 20 mm	6 in 152 mm
57-2861	Right Hook	60 x 10 mm	6 in 152 mm
57-2862	Right Hook	60 x 20 mm	6 in 152 mm
57-2871	Right Hook	70 x 10 mm	6 in 152 mm
57-2872	Right Hook	70 x 20 mm	6 in 152 mm

## Spine (McCulloch)

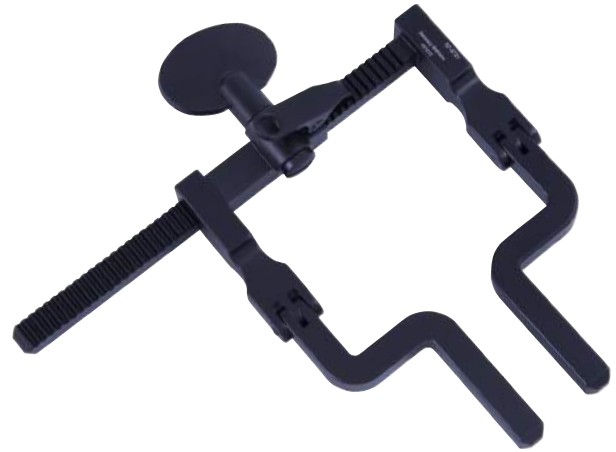

57-5721

### McCulloch Hinged Retractor

Black Finish Blades are for use with Black Finish Frames

CODE	DESCRIPTION
57-5721	Frame Only, Black Finish
57-5721T	Frame Only, Titanium



57-5720

### McCulloch Rigid Retractor

Frame Only

CODE	DESCRIPTION	LENGTH
57-5720	Black blades Must be used with the Black Frame	50 mm
57-5720T	Titanium	60 mm

## Spine (McCulloch)



57-5739

### McCulloch Hook Blade

Sold Individually

CODE	BLADE WIDTH	HOOK DEPTH	
57-5738	Black Finish	$\frac{3}{4}$ in	20 mm
57-5739	Black Finish	$1\frac{1}{8}$ in	30 mm
57-5740 mm	Black Finish	$1\frac{1}{2}$ in	40 mm
57-5741	Black Finish	$1\frac{7}{8}$ in	50 mm
57-5742	Black Finish	$2\frac{3}{8}$ in	60 mm
57-5743	Black Finish	$2\frac{3}{4}$ in	70 mm
57-5751	Black Finish	$3\frac{1}{8}$ in	80 mm



57-5750T

### McCulloch Hook Blade

CODE	DESCRIPTION	HOOK DEPTH	
57-5739T	Titanium	$1\frac{1}{8}$ in	30 mm
57-5740T	Titanium	$1\frac{1}{2}$ in	40 mm
57-5741T	Titanium	$1\frac{7}{8}$ in	50 mm
57-5742T	Titanium	$2\frac{3}{8}$ in	60 mm
57-5743T	Titanium	$2\frac{3}{4}$ in	70 mm
57-5750T	Titanium	$3\frac{1}{8}$ in	80 mm

## Spine (McCulloch)



### McCulloch Multi-Hooked Blade

Sold Individually

57-5746

CODE	DESCRIPTION	HOOK DEPTH	
57-5744	Black Finish	$\frac{3}{4}$ in	20 mm
57-5745	Black Finish	$1\frac{1}{8}$ in	30 mm
57-5746	Black Finish	$1\frac{1}{2}$ in	40 mm
57-5747	Black Finish	$1\frac{7}{8}$ in	50 mm
57-5748	Black Finish	$2\frac{3}{8}$ in	60 mm
57-5749	Black Finish	$2\frac{3}{4}$ in	70 mm
57-5753	Black Finish	$3\frac{1}{8}$ in	80 mm
57-5752	Black Finish	$3\frac{1}{2}$ in	90 mm



57-5745T

### McCulloch Multi-Hooked Blade

CODE	DESCRIPTION	HOOK DEPTH	
57-5744T	Titanium	$\frac{3}{4}$ in	20 mm
57-5745T	Titanium	$1\frac{1}{8}$ in	30 mm
57-5746T	Titanium	$1\frac{1}{2}$ in	40 mm
57-5747T	Titanium	$1\frac{7}{8}$ in	50 mm
57-5748T	Titanium	$2\frac{3}{8}$ in	60 mm
57-5749T	Titanium	$2\frac{3}{4}$ in	70 mm



57-5793

### McCulloch Thin Muscle Blade

Black Finish, Sold individually

CODE	BLADE W X D
57-5793	$\frac{1}{16}$ x $1\frac{1}{2}$ in 17 x 40 mm
57-5794	$\frac{1}{16}$ x $1\frac{7}{8}$ in 17 x 50 mm
57-5795	$\frac{1}{16}$ x $1\frac{3}{8}$ in 17 x 60 mm
57-5796	$\frac{1}{16}$ x $2\frac{3}{4}$ in 17 x 70 mm

## Spine (McCulloch)



### McCulloch Narrow Muscle Retractor Blade

57-5732

1 Pair

CODE	DESCRIPTION	HOOK DEPTH	
57-5732	Black Finish	$\frac{3}{4}$ in	30 mm
57-5733	Black Finish	$1\frac{1}{8}$ in	40 mm
57-5734	Black Finish	$1\frac{1}{2}$ in	50 mm
57-5735	Black Finish	$1\frac{7}{8}$ in	60 mm
57-5736	Black Finish	$2\frac{3}{8}$ in	70 mm
57-5737	Black Finish	$2\frac{3}{4}$ in	80 mm
57-5772	Black Finish	$3\frac{1}{8}$ in	90 mm
57-5773	Black Finish	$3\frac{1}{2}$ in	100 mm
57-5774	Black Finish	$4\frac{1}{4}$ in	110 mm
57-5775	Black Finish	$4\frac{5}{8}$ in	120 mm



### McCulloch Narrow Muscle Retractor Blade

57-5781T

1 Pair

CODE	DESCRIPTION	HOOK DEPTH	
57-5732T	Titanium	$\frac{3}{4}$ in	30 mm
57-5733T	Titanium	$1\frac{1}{8}$ in	40 mm
57-5734T	Titanium	$1\frac{1}{2}$ in	50 mm
57-5735T	Titanium	$1\frac{7}{8}$ in	60 mm
57-5736T	Titanium	$2\frac{3}{8}$ in	70 mm
57-5737T	Titanium	$2\frac{3}{4}$ in	80 mm
57-5781T	Titanium	$3\frac{1}{8}$ in	90 mm

## Spine (McCulloch)



57-5790

### McCulloch Single Cervical Blade

CODE	DESCRIPTION
57-5790-40	2 Teeth, 40 mm
57-5790	2 Teeth, 50 mm
57-5791	2 Teeth, 60 mm
57-5792	2 Teeth, 70 mm



57-5726

### McCulloch Wide Muscle Retractor Blade

2.7 mm Wide

CODE	DESCRIPTION	BLADE DEPTH	
57-5726	Black Finish	$\frac{3}{4}$ in	30 mm
57-5727	Black Finish	$1\frac{1}{8}$ in	40 mm
57-5728	Black Finish	$1\frac{1}{2}$ in	50 mm
57-5729	Black Finish	$1\frac{3}{8}$ in	60 mm
57-5730	Black Finish	$2\frac{3}{8}$ in	70 mm
57-5731	Black Finish	$2\frac{3}{4}$ in	80 mm
57-5783	Black Finish	$3\frac{1}{8}$ in	90mm
57-5784	Black Finish	$3\frac{1}{2}$ in	100 mm
57-5785	Black Finish	$4\frac{1}{4}$ in	110 mm
57-5786	Black Finish	$4\frac{5}{8}$ in	120 mm

## Spine (McCulloch)



57-5730T

### McCulloch Wide Muscle Retractor Blade

1 Pair

CODE	DESCRIPTION	BLADE DEPTH	
57-5726T	Titanium	$\frac{3}{4}$ in	30 mm
57-5727T	Titanium	$1\frac{1}{8}$ in	40 mm
57-5728T	Titanium	$1\frac{1}{2}$ in	50 mm
57-5729T	Titanium	$1\frac{7}{8}$ in	60 mm
57-5730T	Titanium	$2\frac{3}{8}$ in	70 mm
57-5731T	Titanium	$2\frac{3}{4}$ in	80 mm
57-5783T	Titanium	$3\frac{1}{8}$ in	90 mm

## Spine (Nerve Root)



57-5762

### McCulloch Nerve Root Retractor

CODE	LENGTH
57-5761	$\frac{3}{4}$ in 30 mm
57-5762	$1\frac{1}{8}$ in 40 mm

## Spine (Nerve Root)



### Campbell Nerve Root Retractor

CODE	DESCRIPTION	BLADE WIDTH		LENGTH	
50-1326	Malleable Shaft	$\frac{3}{8}$ in	10 mm	$8\frac{1}{2}$ in	216 mm



57-9006

### Caspar Nerve Root Retractor

CODE	DESCRIPTION	BLADE WIDTH		LENGTH	
57-9006		6 mm	6 mm	$9\frac{1}{2}$ in	241 mm
57-9008		8 mm	8 mm	$9\frac{1}{2}$ in	241 mm
57-9010		10 mm	10 mm	$9\frac{1}{2}$ in	241 mm



### D'Errico Nerve Root Retractor

CODE	DESCRIPTION	BLADE WIDTH		LENGTH	
20-1814	Bayonet	$\frac{1}{4}$ in	6 mm	9 in	229 mm



### Flexible Nerve Root Retractor

CODE	DESCRIPTION	BLADE LENGTH		BLADE WIDTH		LENGTH	
50-1209	Nerve Root Retractor	1 in	25 mm	$\frac{5}{16}$ in	8 mm	$8\frac{1}{2}$ in	216 mm



## Spine (Nerve Root)



### Holsher Nerve Root Retractor

CODE	DESCRIPTION	BLADE WIDTH	LENGTH
50-1331	Nerve Root Retractor	$\frac{5}{16}$ in 7 mm	9 $\frac{3}{4}$ in 248 mm



50-1315

### Love Nerve Root Retractor

CODE	DESCRIPTION	BLADE WIDTH	SHAFT LENGTH	LENGTH
50-1315	Straight	$\frac{1}{4}$ in 6 mm	4 in 102 mm	7 $\frac{5}{8}$ in 194 mm
50-1316	90° Angle	$\frac{1}{4}$ in 6 mm	4 in 102 mm	3 $\frac{3}{4}$ in 95 mm
50-1317	135° Angle	$\frac{1}{4}$ in 6 mm	4 in 102 mm	3 $\frac{1}{4}$ in 83 mm



50-1291

### Scoville Nerve Root Retractor

90° Angle

CODE	BLADE WIDTH	SHAFT LENGTH	HANDLE LENGTH
50-1291	$\frac{5}{16}$ in 8 mm	4 $\frac{1}{4}$ in 108 mm	5 in 127 mm
50-1293	$\frac{1}{2}$ in 13 mm	4 $\frac{1}{4}$ in 108 mm	5 in 127 mm

## Spine (Nerve Root)



### Smith Nerve Root Suction Retractor

CODE	DESCRIPTION	SHAFT LENGTH	TIP WIDTH	TIP DEPTH
50-1275	With Obturator and Thumb Control for Suction	5¼ in 133 mm	¼ in 6mm	⅛ in 3mm



### Weary Nerve Root Retractor

CODE	BLADE WIDTH	SHAFT LENGTH	HANDLE LENGTH
50-1310	⅞ in 11 mm	5¾ in 146 mm	5¾ in 146 mm

## Spine (Self-Retaining)



50-1050

### Blade Retractor

CODE	WIDTH	LENGTH	HANDLE LENGTH	CODE	WIDTH	LENGTH	HANDLE LENGTH
50-1050	18 mm	3 in 76 mm	4½ in 114 mm	50-1053	23 mm	3 in 76 mm	4½ in 114 mm
50-1052	20 mm	3 in 76 mm	4½ in 114 mm				

## Spine (Bookwalter®)



### Bookwalter® Spinal Retractor Kit, 12 inch Post (305mm)

CODE	DESCRIPTION	LENGTH	
50-4631	Bookwalter® Spinal Retractor Kit		
50-4581	Table Post	12 in	304 mm
50-4582	Horizontal Flex Bar		
50-4635	Small, 1 Pair	8 ½ in	216 mm
50-4636	Straight Ring Segment (Pair)	4 in	102 mm
50-4637	Straight Ring Segment (Pair)	6 in	152 mm
50-4638	Straight Ring Segment (Pair)	8 in	203 mm
50-4580	Case Holds Six-Each Tilting Ratchet Mechanisms		
50-4639	Bookwalter® Scoville Hook, Small	2 in	50 mm
50-4640	Bookwalter® Scoville Hook, Large	3 ¼ in	83 mm
50-4641	Bookwalter®-Meyerding Retractor Blade, Small	⅔ x 2 ⅓ in	17 x 60 mm
50-4642	Bookwalter®-Meyerding Retractor Blade, Medium	1 x 3 ½ in	25 x 85 mm
50-4643	Bookwalter®-Meyerding Retractor Blade, Large	2 x 3 ¾ in	50 x 95 mm
50-4645	Bookwalter® Rake Retractor-Medium, Rake Retractor, 4 Prong	⅓ x ¾ in	8 ⅔ x 19 mm
50-4646	Bookwalter® Rake Retractor-Large, Rake Retractor, 6 Prong	⅓ x 1 in	8 ⅔ x 25 mm
50-4644	Bookwalter® Rake Retractor-Deep, Rake Retractor, 3 Prong	¾ x ⅔ in	19 x 17 mm
50-4647	Bookwalter® Spinal Retractor, Storage/Sterilizing Case; Depth 4 in (100 mm)	19 ½ x 13 ½ in	500 x 340 mm

## Spine (Bookwalter®)

### Bookwalter® Anterior Lumbar Retractor System

CODE	DESCRIPTION	QTY
50-5740	Bookwalter® Anterior Lumbar Spinal Kit Includes the Following:	
50-4688	Bookwalter® Lightweight Table Post, 12 in	1
50-4554	Bookwalter® Table Post Coupling	1
50-4582	Bookwalter® Lightweight Horizontal Flex Bar	1
50-4583	Bookwalter® Segmented Ring, Medium	1
50-4588	Bookwalter® Segmented Ring, Large	1
50-4696	Bookwalter® Self-Retaining Rotilt Ratchet	6
50-5580	Bookwalter® 1x4 Radiolucent Titanium Retractor Blade	2
50-5581	Bookwalter® 1x5 Radiolucent Titanium Retractor Blade	2
50-5587	Bookwalter® 2x6 Radiolucent Titanium Retractor Blade	2
50-5588	Bookwalter® 2x7 Radiolucent Titanium Retractor Blade	2
50-5589	Bookwalter® 2x8 Radiolucent Titanium Retractor Blade	2
67-7504	Bookwalter® 2x11 Opti-Length® Malleable Retractor Blade with Malleable Lip	1

## Kits (Anterior Cervical Fusion)



59-0600



59-0000

### Ultra™ ReVeal ACF Distraction System

Tray One of Three

CODE	DESCRIPTION	COLOR	LENGTH	QTY
59-0000	Complete System: Tray One of Three			1
59-0030	ACF Blade, Blunt	Silver	1 1/8 in 30 mm	2
59-0031	ACF Blade, Blunt	Blue	1 3/8 in 35 mm	2
59-0032	ACF Blade, Blunt	Red	1 5/8 in 40 mm	2
59-0033	ACF Blade, Blunt	Green	1 3/4 in 45 mm	2
59-0034	ACF Blade, Blunt	Violet	2 in 50 mm	2
59-0035	ACF Blade, Blunt	Black	2 1/8 in 55 mm	2
59-0036	ACF Blade, Blunt	Gold	2 3/8 in 60 mm	2
59-0037	ACF Blade, Blunt	Navy	2 1/2 in 65 mm	2
59-0038	ACF Blade, Blunt	Light Green	2 3/4 in 70 mm	2
59-0039	ACF Blade, Blunt	Orange	3 in 75 mm	2
59-0080	ACF Micro Blade, Blunt	Blue	9/16 x 1 3/8 in 14 x 35 mm	2
59-0081	ACF Micro Blade, Blunt	Red	9/16 x 1 5/8 in 14 x 40 mm	2
59-0082	ACF Micro Blade, Blunt	Green	9/16 x 1 3/4 in 14 x 45 mm	2
59-0083	ACF Micro Blade, Blunt	Violet	9/16 x 2 1/8 in 14 x 50 mm	2
59-0084	ACF Micro Blade, Blunt	Black	9/16 x 2 1/8 in 14 x 55 mm	2
59-0085	ACF Micro Blade, Blunt	Gold	9/16 x 2 1/8 in 14 x 50 mm	2
59-0090	ACF Micro Blade, Short Teeth	Blue	9/16 x 1 3/8 in 14 x 35 mm	2
59-0091	ACF Micro Blade, Short Teeth	Red	9/16 x 1 5/8 in 14 x 40 mm	2
59-0092	ACF Micro Blade, Short Teeth	Green	9/16 x 1 3/4 in 14 x 45 mm	2
59-0093	ACF Micro Blade, Short Teeth	Violet	9/16 x 2 1/8 in 14 x 50 mm	2
59-0094	ACF Micro Blade, Short Teeth	Black	9/16 x 2 1/8 in 14 x 55 mm	2
59-0095	ACF Micro Blade, Short Teeth	Gold	9/16 x 2 3/8 in 14 x 60 mm	2
59-0106	ACF Color Coded Depth Gauge			1
59-0105	Blade Loading Locking Retractor Handle			2

## Kits (Anterior Cervical Fusion)



### Ultra™ ReVeal ACF Removal Body Tray

Tray Two of Three

CODE	DESCRIPTION	COLOR	LENGTH	QTY
59-0000	Complete System, Continued: Tray Two of Three			1
59-0050	ACF Blade, Short Teeth	Silver	1 1/8 in 30 mm	1
59-0051	ACF Blade, Short Teeth	Blue	1 3/8 in 35 mm	1
59-0052	ACF Blade, Short Teeth	Red	1 5/8 in 40 mm	1
59-0053	ACF Blade, Short Teeth	Green	1 3/4 in 45 mm	1
59-0054	ACF Blade, Short Teeth	Violet	2 in 50 mm	1
59-0055	ACF Blade, Short Teeth	Black	2 1/8 in 55 mm	1
59-0056	ACF Blade, Short Teeth	Gold	2 3/8 in 60 mm	1
59-0057	ACF Blade, Short Teeth	Navy	2 1/2 in 65 mm	1
59-0070	ACF Blade, Long Teeth	Silver	1 1/8 in 30 mm	1
59-0071	ACF Blade, Long Teeth	Blue	1 3/8 in 35 mm	1
59-0072	ACF Blade, Long Teeth	Red	1 5/8 in 40 mm	1
59-0073	ACF Blade, Long Teeth	Green	1 3/4 in 45 mm	1
59-0074	ACF Blade, Long Teeth	Violet	2 in 50 mm	1
59-0075	ACF Blade, Long Teeth	Black	2 1/8 in 55 mm	1
59-0076	ACF Blade, Long Teeth	Gold	2 3/8 in 60 mm	1
59-0077	ACF Blade, Long Teeth	Navy	2 1/2 in 65 mm	1
59-0101	Side-Loading Longitudinal Retractor, with Double Hinge			1
59-0100	Side-Loading Transverse Retractor, with Double Hinge		4 3/4 in 120 mm	1
59-0113	Screw Driver			2
59-0109	Twist Drill			2

## Kits (Anterior Cervical Fusion)



### Ultra™ ReVeal ACF Cervical Retractor Tray

Tray Three of Three

CODE	DESCRIPTION	QTY
59-0000	Complete System, Continued: Tray Three of Three	1
59-0131	Bone Graft Holder	1
59-0117	Distractor Single Level, Left with 3 <sup>15</sup> / <sub>16</sub> in (100 mm) Rack	1
59-0118	Distractor Single Level, Right with 3 <sup>15</sup> / <sub>16</sub> in (100 mm) Rack	1
59-0116	Distractor Multiple Level, Left with 4 <sup>3</sup> / <sub>4</sub> in (120 mm) Rack	1
59-0115	Distractor Multiple Level, Right with 4 <sup>3</sup> / <sub>4</sub> in (120 mm) Rack	1
59-0111	Drill Guide, Left for 59-0116/59-0117	1
59-0110	Drill Guide, Right for 59-0118/59-0115	1
59-0120	ACF Caliper	1
59-0124	ACF Bone Graft Harvesting Forcep, <sup>3</sup> / <sub>11</sub> in (7 mm)	1
59-0121	ACF Bone Tamp, <sup>1</sup> / <sub>8</sub> in (3 mm)	1
59-0122	ACF Bone Tamp, <sup>1</sup> / <sub>8</sub> in (5 mm)	1
59-0123	ACF Bone Tamp, <sup>5</sup> / <sub>16</sub> in (8 mm)	1

## Kits (Cervical Retractor)



## Ultra™ ReVeal LoPro Retractor Tray

59-3000

CODE	DESCRIPTION	LENGTH	QUANTITY
59-3000	System Includes the Following:		
59-2001	Cervical Retractor Frame, Right		1
59-2002	Cervical Retractor Frame, Left		1
59-2003	Cervical Retractor Frame, Offset		1
59-2006	Cervical Retractor Blade, Pronged	$\frac{7}{8}$ x 1 in      22 x 25 mm	2
59-2007	Cervical Retractor Blade, Pronged	$\frac{7}{8}$ x $1\frac{1}{8}$ in      22 x 30 mm	2
59-2008	Cervical Retractor Blade, Pronged	$\frac{7}{8}$ x $1\frac{3}{8}$ in      22 x 35 mm	2
59-2009	Cervical Retractor Blade, Pronged	$\frac{7}{8}$ x $1\frac{5}{8}$ in      22 x 40 mm	2
59-2010	Cervical Retractor Blade, Pronged	$\frac{7}{8}$ x $1\frac{3}{4}$ in      22 x 45 mm	2
59-2011	Cervical Retractor Blade, Pronged	$\frac{7}{8}$ x $2\frac{1}{8}$ in      22 x 50 mm	2
59-2012	Cervical Retractor Blade, Pronged	$\frac{7}{8}$ x $2\frac{1}{8}$ in      22 x 55 mm	2
59-2013	Cervical Retractor Blade, Pronged	$\frac{7}{8}$ x $2\frac{3}{8}$ in      22 x 60 mm	2
59-2014	Cervical Retractor Blade, Pronged	$\frac{7}{8}$ x $2\frac{1}{2}$ in      22 x 65 mm	2
59-2015	Cervical Retractor Blade, Pronged	$\frac{7}{8}$ x $2\frac{3}{4}$ in      22 x 70 mm	2
59-2016	Cervical Retractor Blade, Pronged	$\frac{7}{8}$ x 3 in      22 x 75 mm	2
59-2017	Cervical Retractor Blade, Blunt	$\frac{7}{8}$ x 1 in      22 x 25 mm	2
59-2018	Cervical Retractor Blade, Blunt	$\frac{7}{8}$ x $1\frac{1}{8}$ in      22 x 30 mm	2
59-2019	Cervical Retractor Blade, Blunt	$\frac{7}{8}$ x $1\frac{3}{8}$ in      22 x 35 mm	2
59-2020	Cervical Retractor Blade, Blunt	$\frac{7}{8}$ x $1\frac{5}{8}$ in      22 x 40 mm	2
59-2021	Cervical Retractor Blade, Blunt	$\frac{7}{8}$ x $1\frac{3}{4}$ in      22 x 45 mm	2
59-2023	Cervical Retractor Blade, Blunt	$\frac{7}{8}$ x $2\frac{1}{8}$ in      22 x 50 mm	2
59-2024	Cervical Retractor Blade, Blunt	$\frac{7}{8}$ x $2\frac{1}{8}$ in      22 x 55 mm	2
59-2025	Cervical Retractor Blade, Blunt	$\frac{7}{8}$ x $2\frac{3}{8}$ in      22 x 60 mm	2
59-2026	Cervical Retractor Blade, Bi-Leveled Pronged	$1\frac{1}{16}$ x $1\frac{1}{8}$ in      27 x 30 mm	4
59-2028	Cervical Retractor Blade, Bi-Leveled Pronged	$1\frac{1}{16}$ x $1\frac{5}{8}$ in      27 x 40 mm	4
59-2035	Cervical Retractor Blade, Bi-Leveled Pronged	$1\frac{1}{16}$ x $1\frac{3}{4}$ in      27 x 45 mm	4
59-2027	Cervical Retractor Blade, Bi-Leveled Blunt	$1\frac{1}{16}$ x $1\frac{1}{8}$ in      27 x 30 mm	2
59-2029	Cervical Retractor Blade, Bi-Leveled Blunt	$1\frac{1}{16}$ x $1\frac{5}{8}$ in      27 x 40 mm	2
59-2036	Cervical Retractor Blade, Bi-Leveled Blunt	$1\frac{1}{16}$ x $1\frac{3}{4}$ in      27 x 45 mm	2
59-2037	Micro Discectomy Adaptor for ACF Retractor Set		1
59-2038	Spike Blade	$2\frac{3}{4}$ in      70 mm	1
59-2039	T-Shaped Blade	$2\frac{3}{4}$ in      70 mm	1
59-2004	Inner Spine Ligament		1
59-2005	Blade Holding Retractor		2
59-2040	Case		1



## Kits (Cervical Retractor)



### Ultra™ ReVeal Lumbar Instrument

Tray One of Three

59-1000S

CODE	DESCRIPTION	DIMENSIONS		QUANTITY
59-1000S	Ultra™ ReVeal Lumbar System Includes the Following:			1
59-1104	Scoville Lumbar Retractor, Double Hinged	7 $\frac{7}{8}$ in	200 mm	1
59-1100	Lumbar Retractor Body for Multiple Blades			1
59-1103	Side-Loading Lumbar Retractor Blade Holder			4
59-1102	Lumbar Retractor Adjustable Blade Holder			4
59-1001	Lumbar Retractor T-Handle			1
59-1105	Side-Loading Locking Retractor Handle			2
59-1080	Hook, Sharp Toothed Shaft	1 $\frac{5}{8}$ in	40 mm	1
59-1081	Hook, Sharp Toothed Shaft	2 in	50 mm	1
59-1082	Hook, Sharp Toothed Shaft	2 $\frac{3}{8}$ in	60 mm	1
59-1083	Hook, Sharp Toothed Shaft	2 $\frac{3}{4}$ in	70 mm	1
59-1084	Lumbar Spine T-Bar	1 x 1 $\frac{5}{8}$ in	25 x 40 mm	1
59-1085	Lumbar Spine T-Bar	1 x 2 in	25 x 50 mm	1
59-1086	Lumbar Spine T-Bar	1 x 2 $\frac{3}{8}$ in	25 x 60 mm	1
59-1087	Lumbar Spine T-Bar	1 x 2 $\frac{3}{4}$ in	25 x 70 mm	1

### Ultra™ ReVeal Lumbar Instrument System

Tray Two of Three

CODE	DESCRIPTION	DIMENSIONS		QUANTITY
59-1030	Blade Angled Out 15°	$\frac{10}{11}$ x 1 $\frac{3}{8}$ in	23 x 35 mm	4
59-1031	Blade Angled Out 15°	$\frac{10}{11}$ x 1 $\frac{3}{4}$ in	23 x 45 mm	4
59-1032	Blade Angled Out 15°	$\frac{10}{11}$ x 2 $\frac{1}{8}$ in	23 x 55 mm	4
59-1033	Blade Angled Out 15°	$\frac{10}{11}$ x 2 $\frac{1}{2}$ in	23 x 65 mm	4
59-1034	Blade Angled Out 15°	$\frac{10}{11}$ x 3 in	23 x 75 mm	4
59-1035	Blade Angled Out 15°	$\frac{10}{11}$ x 3 $\frac{3}{8}$ in	23 x 85 mm	4
59-1036	Blade Angled Out 15°	$\frac{10}{11}$ x 3 $\frac{15}{16}$ in	23 x 100 mm	4
59-1037	Blade Angled Out 15°	$\frac{10}{11}$ x 4 $\frac{3}{4}$ in	23 x 120 mm	4

## Kits (Cervical Retractor)

### Ultra™ ReVeal Lumbar Instrument System

#### Tray Three of Three

CODE	DESCRIPTION	DIMENSIONS		QUANTITY
59-1050	Blade Angled Out 15°	1 <sup>3</sup> / <sub>4</sub> x 2 in	45 x 50 mm	2
59-1051	Blade Angled Out 15°	1 <sup>3</sup> / <sub>4</sub> x 2 <sup>3</sup> / <sub>8</sub> in	45 x 60 mm	2
59-1052	Blade Angled Out 15°	1 <sup>3</sup> / <sub>4</sub> x 2 <sup>3</sup> / <sub>4</sub> in	45 x 70 mm	2
59-1053	Blade Angled Out 15°	1 <sup>3</sup> / <sub>4</sub> x 3 <sup>1</sup> / <sub>8</sub> in	45 x 80 mm	2
59-1056	Blade Angled Out 15°	2 <sup>3</sup> / <sub>8</sub> x 2 in	60 x 50 mm	2
59-1057	Blade Angled Out 15°	2 <sup>3</sup> / <sub>8</sub> x 2 <sup>3</sup> / <sub>8</sub> in	60 x 60 mm	2
59-1058	Blade Angled Out 15°	2 <sup>3</sup> / <sub>8</sub> x 2 <sup>3</sup> / <sub>4</sub> in	60 x 70 mm	2
59-1059	Blade Angled Out 15°	2 <sup>3</sup> / <sub>8</sub> x 3 <sup>1</sup> / <sub>2</sub> in	60 x 80 mm	2
59-1060	Blade Angled Out 15°	2 <sup>3</sup> / <sub>8</sub> x 3 <sup>15</sup> / <sub>16</sub> in	60 x 100 mm	2
59-1061	Blade Angled Out 15°	2 <sup>3</sup> / <sub>8</sub> x 4 <sup>3</sup> / <sub>4</sub> in	60 x 120 mm	2
59-1070	Blade Sacral Cutout, Right	1 <sup>1</sup> / <sub>4</sub> x 1 <sup>5</sup> / <sub>8</sub> in	30 x 40 mm	1
59-1071	Blade Sacral Cutout, Left	1 <sup>1</sup> / <sub>4</sub> x 1 <sup>5</sup> / <sub>8</sub> in	30 x 40 mm	1
59-1072	Blade Sacral Cutout, Right	2 <sup>3</sup> / <sub>8</sub> x 1 <sup>3</sup> / <sub>4</sub> in	60 x 45 mm	1
59-1073	Blade Sacral Cutout, Left	2 <sup>3</sup> / <sub>8</sub> x 1 <sup>3</sup> / <sub>4</sub> in	60 x 45 mm	1
59-1700	Case			1

## Splanchnic



23-7040

### Harrington Splanchnic Retractor

CODE	BLADE	LENGTH	
23-7040	42 x 127 mm	12 <sup>1</sup> / <sub>2</sub> in	316 mm
23-7062	62 x 127 mm	12 <sup>1</sup> / <sub>2</sub> in	316 mm



23-7106

### Harrington-Pemberton Retractor

CODE	DESCRIPTION	SIZE		LENGTH	
23-7040	Retractor	1 <sup>5</sup> / <sub>8</sub> x 5 in	41 x 127 mm	12 <sup>1</sup> / <sub>2</sub> in	318 mm
23-7106	Retractor	2 <sup>1</sup> / <sub>2</sub> x 7 <sup>1</sup> / <sub>8</sub> in	64 x 181 mm	12 <sup>1</sup> / <sub>2</sub> in	318 mm

## Sternal

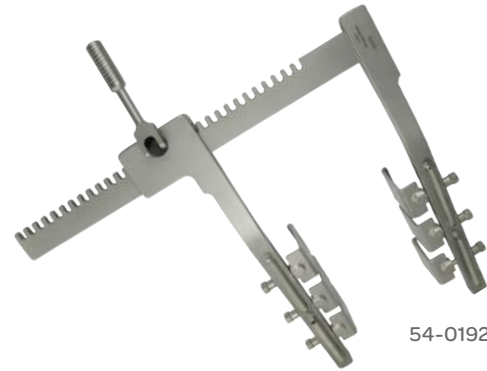

54-0192

### Ankeney Sternal Retractor

CODE	DESCRIPTION
54-0192	Self-Retaining with Rack and Pinion Action. Complete with Six Detachable Swivel Blades and One Pair of Springs on Each Arm
54-0194	Set of Six Blades



30-9025

### Castaneda Instrument Kit

CODE	DESCRIPTION	DIMENSION	
30-9025	Kit Includes the Following:		
30-9000	Multi-Purpose Clamp, Angled 30°		
30-9001	Multi-Purpose Clamp, Angled 50°		
30-9002	Partial Occlusion Clamp, Spoon Shape		
30-9003	Anastomosis Clamp, Small		
30-9004	Anastomosis Clamp, Medium		
30-9005	Anastomosis Clamp, Large, Castaneda Retractors	4 <sup>5</sup> / <sub>16</sub> in	110 mm
50-8060	Sternal Retractor, Small		
50-8061	Sternal Retractor, Large		
30-8500	Vascular Forceps, Titanium, 2/Each	6 in	152 mm
19-8150	Mixer Clamp, Smooth Jaw	5 <sup>1</sup> / <sub>4</sub> in	133 mm
21-8010	Castaneda Instrument Case	11x7x2 in	279x178x51 mm

## Sternal



## Collins Radiopaque Sternal Blades

CODE	DESCRIPTION
50-8080	Arm length 8 <sup>3</sup> / <sub>4</sub> (222 mm), Total Opening 8 <sup>1</sup> / <sub>8</sub> in (206 mm)



## Cooley Sternal Retractor

54-1009

CODE	ARM LENGTH		BLADE LENGTH		BLADE DEPTH		SPREAD	
54-1009	3 <sup>1</sup> / <sub>8</sub> in	79 mm	<sup>3</sup> / <sub>4</sub> in	20 mm	<sup>1</sup> / <sub>2</sub> in	14 mm	4 in	100 mm
54-1003	5 <sup>3</sup> / <sub>4</sub> in	145 mm	2 in	50 mm	1 <sup>3</sup> / <sub>8</sub> in	35 mm	8 <sup>1</sup> / <sub>4</sub> in	209 mm
54-1006	8 <sup>1</sup> / <sub>2</sub> in	215 mm	4 <sup>3</sup> / <sub>8</sub> in	110 mm	1 <sup>3</sup> / <sub>8</sub> in	35 mm	9 <sup>3</sup> / <sub>8</sub> in	238 mm



## Favaloro-Morse Sternal Retractor

With Two Pair of Fixed Sternal Blades

CODE	ARM LENGTH		BLADE LENGTH		BLADE DEPTH		SPREAD	
54-1860	6 in	150 mm	1 <sup>1</sup> / <sub>2</sub> in	40 mm	1 <sup>1</sup> / <sub>2</sub> in	40 mm	8 in	200 mm



## Himmelstein Sternal Retractor

Self-Retaining with Ratchet Action and Flexible Arms

CODE	TOTAL OPENING		BLADE WIDTH		BLADE DEPTH		ARM LENGTH		LENGTH	
50-1133	5 in	127 mm	1 <sup>1</sup> / <sub>8</sub> in	35 mm	1 <sup>1</sup> / <sub>4</sub> in	32 mm	5 <sup>1</sup> / <sub>4</sub> in	133 mm	5 in	127 mm

## Sternal



### Morse Sternal Retractor

50-8066

Child and Adult Self-Retaining with Rack and Pinion Action

CODE	TOTAL OPENING	BLADE WIDTH	BLADE DEPTH	ARM LENGTH	LENGTH
50-8066	6 ¼ in 159 mm	¾ in 19 mm	¾ in 19 mm	6 in 152 mm	6 ¼ in 159 mm
50-8067	8 in 203 mm	1 ⅛ in 29 mm	1 in 25 mm	7 ½ in 191 mm	8 in 203 mm



### Pacifico Sternal Retractor

Self-Retaining

CODE	TOTAL OPENING	UPPER & LOWER BLADE WIDTH	LOWER BLADE DEPTH	ARM LENGTH	LENGTH
50-8085	8 in 203 mm	¾ in 19 mm	1 ½ in 38 mm	6 in 152 mm	8 in 203 mm

## Thoracotomy



### Heitmiller Mini Thoracotomy Retractor

CODE	DESCRIPTION
54-2340	Mini Thoracotomy Retractor

## Thymus



### Thymus Retractor

CODE	DESCRIPTION	LENGTH
20-0707	Double-Ended	6 3/4 in 170 mm

## Thymus (Hand-Held)



23-0306

### Lahey Retractor

CODE	DESCRIPTION	BLADE (W X D)	LENGTH
23-0306	Retractor	6 x 3 mm	7 3/4 in 197 mm
50-4040C	Thyroid Retractor	1/4 x 1 in 6 x 25 mm	8 1/8 in 206 mm

## Thyroid



### Green Thyroid Retractor

CODE	DESCRIPTION	LENGTH
23-3512	Fenestrated Blade	8 1/2 in 215 mm

## Thyroid

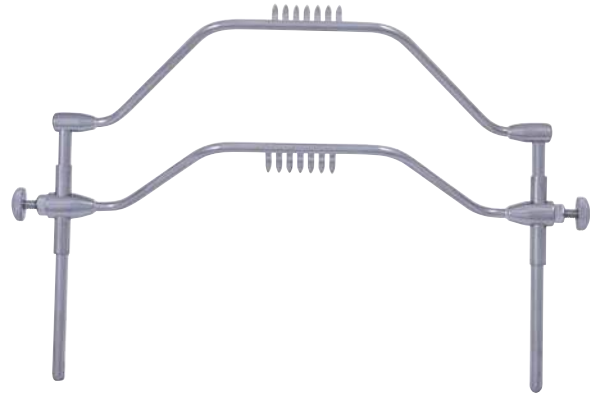

### Mahorner Thyroid Retractor

CODE	DESCRIPTION	LENGTH
24-0888	7 Prong	10½ in 267 mm



20-1782

### McBurney Thyroid Retractor

CODE	DESCRIPTION	LENGTH
20-1782	Fenestrated	7½ in 191 mm

## Tonsil



### Hurd Tonsil Dissector & Pillar Retractor

CODE	TIP SIZE	LENGTH
65-6600	½ in 13 mm	8¾ in 222 mm

## Tracheal



## Jackson Tracheal Retractor

CODE	DESCRIPTION	LENGTH
20-0708	Double-Ended	6 <sup>3</sup> / <sub>4</sub> in 170 mm



## News Tracheal Hook

CODE	DESCRIPTION	LENGTH
20-4015	Single Prong	6 in 150 mm

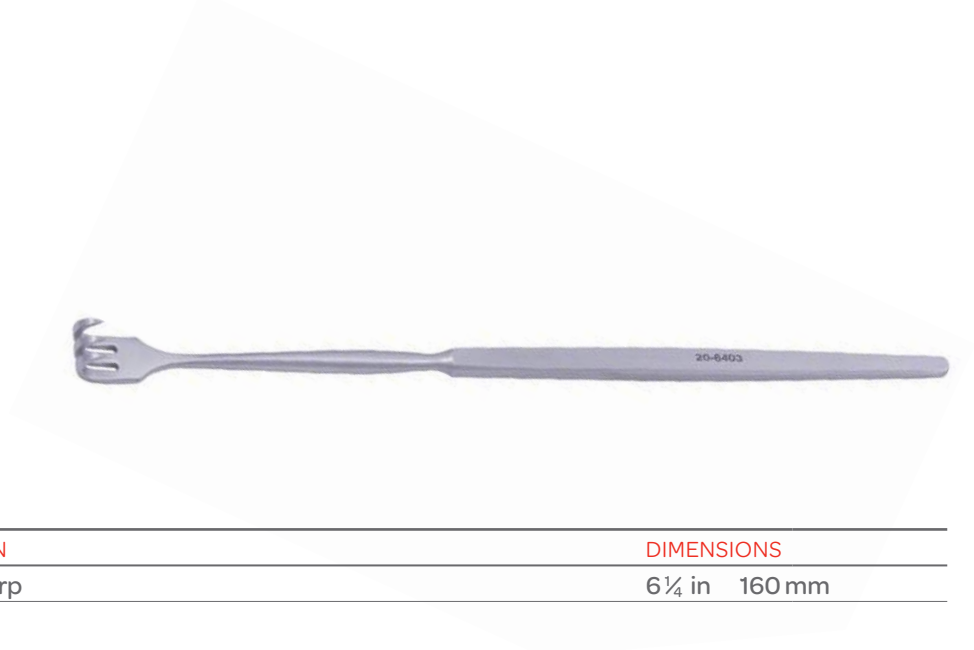

## Tracheal Retractor

CODE	DESCRIPTION	DIMENSIONS
20-6403	3 Prong, Sharp	6 <sup>1</sup> / <sub>4</sub> in 160 mm



## Uvula



### Goodyear Uvula Retractor

CODE	WIDTH	LENGTH
71-6348	15 mm	7½ in 190 mm



### Love Uvula Retractor

CODE	DESCRIPTION	LENGTH
71-6318	18 mm	6½ in 165 mm
71-6320	20 mm	6½ in 165 mm



71-6318

### Love Uvula Retractor

CODE	WIDTH	LENGTH
71-6318	18 mm	6½ in 165 mm
71-6320	20 mm	6½ in 165 mm

## Vaginal (Bookwalter®)



50-4592

### Bookwalter®-Magrina Deaver Blade

CODE	DESCRIPTION	DIMENSIONS	
50-4592	Small	1 x 3 ½ in	25 x 89 mm
50-4593	Large	1 x 5 in	25 x 127 mm



### Bookwalter®-Magrina Lateral Blade

CODE	DESCRIPTION	LENGTH	
50-4591	45°	1 x 3 in	25 x 76 mm

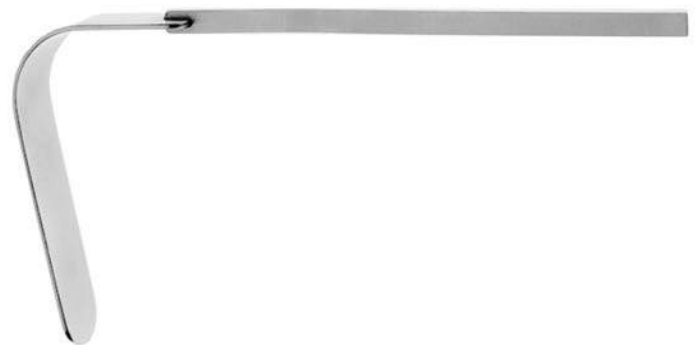

### Bookwalter®-Magrina Posterior Blade

CODE	DESCRIPTION	LENGTH	
50-4594	Posterior Blade	1 x 4 ½ in	25 x 114 mm

## Vaginal (Bookwalter®)



50-4547

### Bookwalter®-Magrina Retractor System

CODE	NAME	QTY
50-4692	Vaginal Retractor Kit Includes Following Items:	
50-4688	Bookwalter® Lightweight Table Post, 12 in	1
50-4554	Bookwalter® Post Coupler	1
50-4582	Bookwalter® Lightweight Horizontal Flex Bar	1
50-4689	Bookwalter® -Magrina Segmented Ring with Suture Slots	1
50-4586	Bookwalter® Self-Retaining Tilting Ratchet	6
50-4694	Bookwalter® 1x4 Malleable Lateral Retractor Blade	2
50-4592	Bookwalter® -Magrina Deaver Blade, Small	1
50-4593	Bookwalter® -Magrina Deaver Blade, Large	1
50-4594	Bookwalter® -Magrina Posterior Retractor Blade	1

## Vaginal (Bookwalter®)

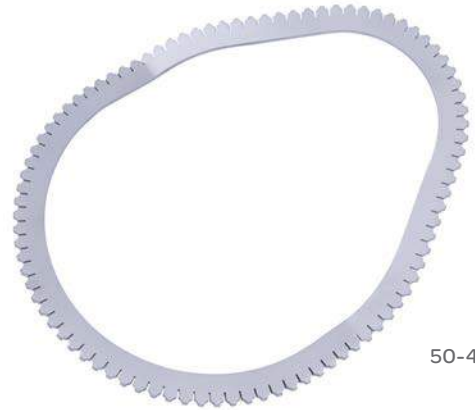

50-4690

### Bookwalter®-Magrina Pelvic Rings

CODE	DESCRIPTION	LENGTH
50-4590	Fixed Basic Ovoid Ring	8 x 10 ½ in 203 x 267 mm
50-4690	Fixed Ovoid Ring with Suture Slots	8 x 10 ½ in 203 x 267 mm
50-4689	Segmented Ovoid Ring with Suture Slots	8 x 10 ½ in 203 x 267 mm



52-2601

### Breisky Vaginal Retractor

Slight Curve

CODE	No.	LENGTH
52-2601	#1	¾ x 4 in 19 x 102 mm
52-2602	#2	1 x 4 in 25 x 102 mm
52-2603	#3	1¼ x 4 in 32 x 102 mm
52-2604	#4	1⅜ x 4 in 35 x 102 mm
52-2605	#5	1⅝ x 4 in 41 x 102 mm
52-2606	#6	1⅞ x 4 ¾ in 29 x 121 mm
52-2607	#7	1⅜ x 5⅞ in 35 x 130 mm
52-2609	#9	1⅜ x 6¼ in 35 x 159 mm
52-2610	#10	1 x 6 ⅞ in 25 x 170 mm

## Vaginal



52-2332

### Eastman Vaginal Retractor

CODE	No.	LENGTH
52-2331	#1	1 $\frac{3}{8}$ x 3 in 35 x 76 mm
52-2332	#2	1 $\frac{3}{8}$ x 3 $\frac{1}{2}$ in 35 x 89 mm
52-2333	#3	1 $\frac{5}{8}$ x 4 in 41 x 102 mm



50-5570

### Heaney-Simon Vaginal Retractor

CODE	BLADE	LENGTH
50-5570	1 x 4 $\frac{1}{2}$ in 25 x 114 mm	10 $\frac{1}{4}$ in 260 mm
52-2727	1 x 4 $\frac{1}{2}$ in 25 x 114 mm	11 in 279 mm

## Vaginal



50-5540

## Jackson Vaginal Retractor

CODE	SIZE	BLADE	LENGTH
52-2301	#1	1 <sup>3</sup> / <sub>8</sub> x 3 in 35 x 76 mm	7 <sup>1</sup> / <sub>4</sub> in 184 mm
52-2302	#2	1 <sup>3</sup> / <sub>8</sub> x 3 <sup>1</sup> / <sub>2</sub> in 35 x 89 mm	7 <sup>1</sup> / <sub>4</sub> in 184 mm
52-2303	#3	1 <sup>1</sup> / <sub>2</sub> x 4 in 38 x 102 mm	7 <sup>1</sup> / <sub>4</sub> in 184 mm
50-5540	Small	1 <sup>1</sup> / <sub>2</sub> x 3 in 38 x 76 mm	6 <sup>3</sup> / <sub>4</sub> in 171 mm
50-5541	Medium	1 <sup>1</sup> / <sub>2</sub> x 3 <sup>1</sup> / <sub>2</sub> in 38 x 89 mm	6 <sup>3</sup> / <sub>4</sub> in 171 mm
50-5542	Large	1 <sup>1</sup> / <sub>2</sub> x 4 in 38 x 102 mm	6 <sup>3</sup> / <sub>4</sub> in 171 mm



52-0799I

## Lateral Vaginal Wall Retractor

CODE	DESCRIPTION	BLADE	LENGTH
52-0799I	Insulated	1 x 2 <sup>1</sup> / <sub>2</sub> in 25 x 64 mm	10 <sup>3</sup> / <sub>4</sub> in 270 mm
52-0799E	Ebonized	1 x 2 <sup>1</sup> / <sub>2</sub> in 25 x 64 mm	10 <sup>3</sup> / <sub>4</sub> in 270 mm
52-0799		1 x 2 <sup>1</sup> / <sub>2</sub> in 25 x 64 mm	10 <sup>3</sup> / <sub>4</sub> in 270 mm

## Vaginal



52-2020

### Sims Vaginal Retractor

Hollow Grip Retractor

CODE	DESCRIPTION	LENGTH	
52-2020	Small	2½ x 1 in	64 x 25 mm
52-2021	Medium	3 x 1¼ in	76 x 32 mm
52-2022	Large	3½ x 1½ in	89 x 38 mm



### Weinberg Vagotomy Retractor

CODE	DESCRIPTION	DIMENSIONS				LENGTH	
23-5917	Double-Ended	2 x 2½ in	51 x 38 mm	3½ in x 6¼ in	89 x 159 mm	9½ in	241 mm

## Vascular



## Garrett Multi Purpose Peripheral Vascular Retractor

CODE	DESCRIPTION	TOTAL OPENING		BLADE WIDTH		BLADE DEPTH		LENGTH	
50-8015	Self-Retaining, with Three Blades	3½ in	89 mm	1½ in	38 mm	1¼ in	32 mm	7¼ in	184 mm



## Ochsner Vascular Retractor

With Swiveling Blades, Self-Retaining and Flexible Arms

CODE	TOTAL OPENING	BLADE WIDTH		BLADE DEPTH		ARM LENGTH	LENGTH
50-8016	5½ in 140 mm	1 in	25 mm	2 in	51 mm	¾ in 83 mm	8 in 203 mm



## Vascular (Vision)

### Complete Expanded Vision Vascular System

CODE	DESCRIPTION	DIMENSIONS		QTY
59-8865	Includes The Following Items:			
59-8802	Table Clamp w/ Vertical Post			1
59-8803	Retractor Clamp			10
59-8804	Extension Arm, Hinged			1
59-8805	Vision Frame			1
59-8807	Mayo Swivel	2 <sup>3</sup> / <sub>4</sub> x 2 in	70 x 51 mm	2
59-8808	Mayo Swivel	3 <sup>1</sup> / <sub>2</sub> x 2 in	89 x 51 mm	1
59-8809	Deaver Swivel	2 <sup>3</sup> / <sub>4</sub> x 4 <sup>1</sup> / <sub>2</sub> in	70 x 114 mm	1
59-8811	Harrington "Sweetheart"	2 x 5 in	51 x 127 mm	1
59-8815	Malleable Swivel, Perforated	3 x 6 in	76 x 152 mm	1
59-8816	Malleable Swivel, Perforated	3 x 6 <sup>1</sup> / <sub>2</sub> in	76 x 165 mm	1
59-8818	Fence Swivel, Perforated	4 x 6 in	102 x 152 mm	1
59-8820	Splanchnic Swivel	2 x 6 in	51 x 152 mm	1
59-8821	Splanchnic Swivel	2 x 6 in	51 x 152 mm	1
59-8824	Renal Swivel	1 x 6 in	25 x 151 mm	2
59-8801	Post Coupling			1
59-8828	Sterilization Case			1

Note: Individual components are available, in single quantities, by referencing their unique product code upon ordering.



55-9075

### Vascular Spring

CODE	DESCRIPTION	LENGTH	
55-9075	Small	3 <sup>1</sup> / <sub>2</sub> in	88 mm
55-9074	Large	5 <sup>1</sup> / <sub>4</sub> in	133 mm

## Vein



20-1708

## Cushing Vein Retractor

CODE	DESCRIPTION	BLADE	LENGTH	
50-1020	Vein Retractor	13 x 10 mm	9 in	229 mm
50-1022	Vein Retractor	9 x 6 mm	7 <sup>3</sup> / <sub>4</sub> in	197 mm
20-1750	Fenestrated Handle	11 mm	9 in	229 mm
20-1752	Fenestrated Handle	11 mm	14 in	356 mm

## Vessel



Tip

## Malis® Vessel Supporter

CODE	DESCRIPTION	LENGTH	
80-1534	Titanium Handle, Stainless Steel Shaft, 2 Prong	7 <sup>3</sup> / <sub>8</sub> in	187 mm